



# Thyristor-Power Controller

## PMA-Relay S 2PH

### from 60A to 210A

## User Manual



PMA-S2-60-210A

Valid from: 30.06.2019

Order number: 9499-040-96411

**A publication of:**

**PMA**  
**Prozeß- und Maschinen-Automation GmbH**  
**P.O.Box 310 229 • D-34058 Kassel • Germany**

All rights reserved.

No part of this document may be reproduced or published in any form or by any means without prior written permission from the copyright owner.

**Liability and warranty**

Any information and notes in these operating instructions were composed under consideration of the applicable regulations, the present state of the art and our extensive know-how and experience.

With special versions, additional ordering options or due to the latest technical modifications, the actual scope of delivery may vary from the descriptions and drawings in this manual. For questions, please, contact the manufacturer.



**Before starting to work with the instrument and before commissioning, in particular, these operating instructions must be read carefully! The manufacturer cannot be held responsible for damage and trouble resulting from failure to comply with the information given in this manual.**

**This product may be subject to change due to improvements of the product features in the course of further development.**

**Copyright**

This operating manual should be considered as confidential information, intended only for persons who work with the instrument.

Contraventions are subject to payment of damages. Further claims reserved.

## Inhalt







1.	Important warnings for safety.....	4
1.1.	Safety notes.....	4
2.	Maintenance.....	6
3.	Basic Connections.....	7
4.	Identification and Order Code.....	8
4.1.	Identification of the unit .....	8
5.	Order Code .....	9
6.	Technical Specifications.....	10
6.1.	General features.....	10
6.2.	Input features.....	10
6.3.	Output features (power device).....	10
6.4.	Fan Specification (60 to 90A).....	10
6.5.	Fan Specification (120 to 210A).....	10
6.6.	Environmental installation conditions .....	11
6.7.	Derating Curve.....	11
7.	Installation.....	12
7.1.	Dimensions and weight .....	12
7.2.	Fixing holes.....	13
8.	Wiring instructions .....	14
8.1.	Terminals Positions 2PH 60-90A Size .....	14
8.2.	Terminals Positions 2PH 120-210A Size .....	15
8.3.	Power Terminals.....	15
8.4.	Command Terminals .....	16
8.4.1.	Terminal block M1 for SSR Input.....	16
8.4.2.	Terminal block M1 for Analog Input or SSR input with HB .....	16
8.5.	Connection Diagram for 3 phases (control on 2 phases) from 60 to 90A.....	17
8.6.	Connection Diagram for 3 phases (control on 2 phases) from 120 to 210A.....	18
8.7.	Led status and alarms.....	19
9.	Heater Break alarm and SCR short circuit (HB Option only) .....	19
9.1.	Heater break Calibration procedure .....	19
9.2.	HB Alarm contact.....	20
10.	Input setting .....	21
10.1.	Input calibration procedure .....	22
11.	Firing type.....	23
11.1.	Zero Crossing (ZC) with SSR Input .....	23
11.2.	Burst Firing (BF) with Analog Input .....	23
11.3.	Burst Firing settings.....	24
12.	Internal Fuse.....	25
12.1.	Fuses Replacement.....	26
13.	Trouble shooting .....	27

# 1. Important warnings for safety

This chapter contains important information for the safety. The not observance of these instructions may result in serious personal injury or death and can cause serious damages to the Thyristor unit and to the components system included.

The installation should be performed by qualified persons.

In the manual are used symbols to give more evidence at the notes of safety and operativity for the attention for the user:

	This icon is present in all the operational procedures where the Improper operation may result in serious personal injury or death by Electrical Shock Hazard Symbol (a lightning bolt in a triangle) precedes an electric shock hazard CAUTION or WARNING safety statement.
	Warning or Hazard that needs further explanation than the label on unit can provide. Consult User's Guide for further information.
	Unit is compliant with European Union directives. See Declaration of Conformity for further details on Directives and Standards used for Compliance.
	If available, unit is a Listed device per Underwriters Laboratories. It has been investigated to ANSI/UL <sup>®</sup> 508 standards for Industrial Control Switches and equivalent to CSA C22.2 #14. For more detail search for File E505847 on <a href="http://www.ul.com">www.ul.com</a>
	ESD Sensitive product, use proper grounding and handling techniques when installing or servicing product.
	Do not throw in trash, use proper recycling techniques or consult manufacturer for proper disposal.

A “**NOTE**” marks a short message to alert you to an important detail.

A “**CAUTION**” safety alert appears with information that is important for protecting your equipment and performance. Be especially careful to read and follow all cautions that apply to your application.

A “**WARNING**” safety alert appears with information that is important for protecting you, others and equipment from damage. Pay very close attention to all warnings that apply to your application.

## 1.1. Safety notes



**WARNING!** To avoid damage to property and equipment, injury and loss of life, adhere to applicable electrical codes and standard wiring practices when installing and operating this product. Failure to do so could result in damage, injury and death.



**WARNING!** All service including inspection, installation, wiring, maintenance, troubleshooting, fuse or other user serviceable component replacement must be performed only by properly qualified personnel. Service personnel must read this manual before proceeding with work. While service is being performed unqualified personnel should not work on the unit or be allowed in the immediate vicinity.



**WARNING!** When in use the power controller is connected to dangerous voltages. Do not remove the protective covers without first disconnecting and preventing power from being restored while servicing the unit.



**WARNING!** Do not use in aerospace or nuclear applications.



**WARNING!** The power controller's protection rating is IP20 with all covers installed and closed. It must be installed in an enclosure that provides all the necessary additional protections appropriate for the environment and application.



**WARNING!** Ground the power controller via the provided protective earth grounding terminal. Verify ground is within impedance specifications. This should be verified periodically.



**WARNING!** Electric Shock Hazard: when the power controller has been energized, after shutting off the power, wait at least one minute for internal capacitors to discharge before commencing work that brings you in to contact with power connections or internal components.



**WARNING!** The installation must be protected by electromagnetic circuit breakers or by fuses. The semiconductor fuses located inside the power controller are classified for UL as supplementary protection for semiconductor devices. They are not approved for branch circuit protection.



**WARNING!** When making live voltage or current measurements, use proper personal protective equipment for the voltages and arc-flash potentials involved.



**WARNING!** Verify the voltage and current ratings of the power controller are correct for the application.



**CAUTION:** To avoid compromising the insulation, do not bend wire or other components beyond their bend radius specifications.



**CAUTION:** Protect the power controller from high temperature, humidity and vibrations.



**CAUTION:** The power controller warranty is void if the tested and approved fuses are not used.



**CAUTION:** Only trained and authorized personnel should access and handle the internal electronics and they must follow proper electro-static prevention procedures.



**CAUTION:** Install an appropriately sized RC filter across contactor coils, relays and other inductive loads.



**CAUTION:** The thyristor units here described have been designed for use with sinusoidal networks with nominal frequency 50-60 Hz. Any application with NON-SINUSOIDAL, distorted or disturbed networks could compromise the correct operation of the unit.



**NOTE:** Provide a local disconnect to isolate the power controller for servicing.



**NOTE:** The nominal current is specified for ambient temperatures at or below 40° C. Ensure the application design allows for adequate cooling of each power controller. The power controller must be mounted vertically. The cooling design must prevent air heated by one power controller from causing power controllers mounted above to exceed the ambient operating temperature limit. When power controllers are mounted side by side allow a minimum spacing of 15mm between them.



**NOTE:** Use only copper cables and wires rated for use at 75°C or greater.

## 2. Maintenance

In order to have a corrected cooling, the user must clean the heat-sink and the protective grill of the fans.

The frequency of this servicing depends on environmental pollution.

Also check periodically if the screw for the power cables and safety earth are tightened correctly (See Connection Diagram)

### 3. Basic Connections

#### Star wiring with resistive load (control on two phases)

$$I = \frac{P}{1.73V}$$

V = Nominal voltage of the load

I = Nominal current of the load

P = Nominal power of the load

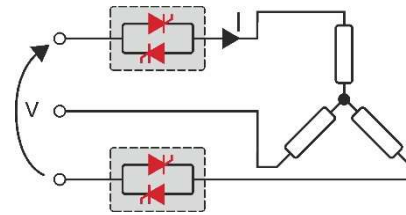

#### Delta wiring with resistive load (control on two phases)

$$I = \frac{P}{1.73}$$

V = Nominal voltage of the load

I = Nominal current of the load

P = Nominal power of the load

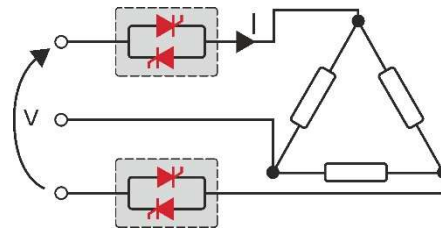

## 4. Identification and Order Code

### 4.1. Identification of the unit



**Caution:** Before to install, make sure that the Thyristor unit have not damages. If the product has a fault, please contact the dealer from which you purchased the product.

The identification label give all the information regarding the factory settings of the Thyristor unit, this label is on the unit, like represented in figure.

Verify that the product is the same thing as ordered.





## 5. Order Code

	RS2	x	x	x	-	x	x	x	x	0	x	x	x	x	x
<b>Current Rating</b>		↓	↓	↓											
60 A		0	6	0											
75 A		0	7	5											
90 A		0	9	0											
120 A		1	2	0											
150 A		1	5	0											
180 A		1	8	0											
210 A		2	1	0											
<b>Max Voltage</b>					↓										
480 V					4										
600 V					6										
690 V					7										
<b>Aux. Voltage Supply</b>						↓									
No Aux. Voltage without HB and/or Analog Input					0										
With HB and/or Analog Input 12:24V ac-dc					4										
<b>Input signal</b>						↓									
(SSR)						S									
0:10 V dc						V									
4:20 mA						A									
<b>Firing</b>							↓								
ZC Zero Crossing							Z								
Burst Firing 4 Cycles On at 50% Power Demand (Available only with Analog Input)							4								
Burst Firing 8 Cycles On at 50% Power Demand (Available only with Analog Input)							8								
Burst Firing 16 Cycles On at 50% Power Demand (Available only with Analog Input)							6								
<b>Control Mode</b>								↓							
Open Loop								0							
<b>Fuses &amp; Option</b>									↓						
Fuse + Fuse Holder									F						
Fuse + Fuse Holder + CT + HB									H						
<b>Fan Voltage</b>										↓					
No Fan < 90A										0					
Fan 110Vac ≥ 90A										1					
Fan 220Vac ≥ 90A Std Version										2					
Fan 24Vdc ≥ 90A										3					
<b>Approvals</b>											↓				
CE EMC For European Market											0				
cUI + CE EMC For American and European Market											L				
<b>Manual</b>												↓			
None												0			
Italian												1			
English												2			
German												3			
French												4			
<b>Version</b>													↓		
Standard unit with one fuse														1	
High Sensitivity HB below 5A														5	

## 6. Technical Specifications

### 6.1. General features

Cover and Socket material	PolymericV2
Utilization Category	AC-51 AC-55b
IP Code	20
Method of Connecting	Load in Delta, Load in Star
Auxiliary voltage (only with HB option)	24V dc/ac (max 70mA)
Relay output for Heater Break Alarm (only with HB option)	0.5A a 125Vac

### 6.2. Input features

Logic input SSR	5 ÷ 30Vdc 9mA Max (ON >5Vdc OFF <4Vdc)
Logic input SSR with HB option	4 ÷ 30Vdc 5mA Max (ON >4Vdc OFF <1Vdc)
Analog Input V	0 ÷ 10Vdc (15 kΩ)
Analog Input A	0 ÷ 20mA / 4 ÷ 20mA (100 Ω)
Digital Input calib. (only with HB option)	12 ÷ 24V dc/ac (max 4mA)

### 6.3. Output features (power device)

Current	Nominal Voltage range (Ue)	Repetitive peak reverse voltage (Uimp)		Latching current	Max peak one cycle	Leakage current	FUSE I2T value Suggested A2s (at500V)	Frequency range	Power loss Thyristor + Fuse	Isolation Voltage (Ui)
		(480V)	(600V)							
(A)	(V)	(480V)	(600V)	(mAeff)	(10msec.) (A)	(mAeff)	tp = 10msec.	(Hz)	I=Inom (W)	(V)
60	24÷600	1200	1600	600	1900	15	8680	47÷70	205	3000
90*	24÷600	1200	1600	600	1900	15	8680	47÷70	290	3000
120	24÷600	1200	1600	600	1900	15	14280	47÷70	398	3000
150	24÷600	1200	1600	300	5000	15	17500	47÷70	409	3000
180	24÷600	1200	1600	300	5000	15	30800	47÷70	469	3000
210	24÷600	1200	1600	300	5000	15	53900	47÷70	598	3000

\*75A for UL

### 6.4. Fan Specification (60 to 90A)

Supply: 230Vac Standard                      Power 16W (1 Fan)

Supply: 115Vac Option                        Power 14W (1 Fan)

Supply: 24Vdc Option                         Power 7W (1 Fan)

### 6.5. Fan Specification (120 to 210A)

Supply: 230Vac Standard                      Power 32W (16W for 2 Fans)

Supply: 115Vac Option                        Power 28W (14W for 2 Fans)

Supply: 24Vdc Option                         Power 14W (7W for 2 Fans)

## 6.6. Environmental installation conditions

Ambient temperature	0-40°C (32-104°F) at nominal current. Over 40°C -104°F use the derating curve.
Storage temperature	-25°C to 70°C -13°F to 158°F
Installation place	Don't install at direct sun light, where there are conductive dust, corrosive gas, vibration or water and also in salty environmental.
Altitude	Up to 1000 meter over sea level. For higher altitude reduce the nominal current of 2% for each 100m over 1000m
Humidity	From 5 to 95% without condense and ice
Pollution Level	Up to 2nd Level ref. IEC 60947-1 6.1.3.2

## 6.7. Derating Curve

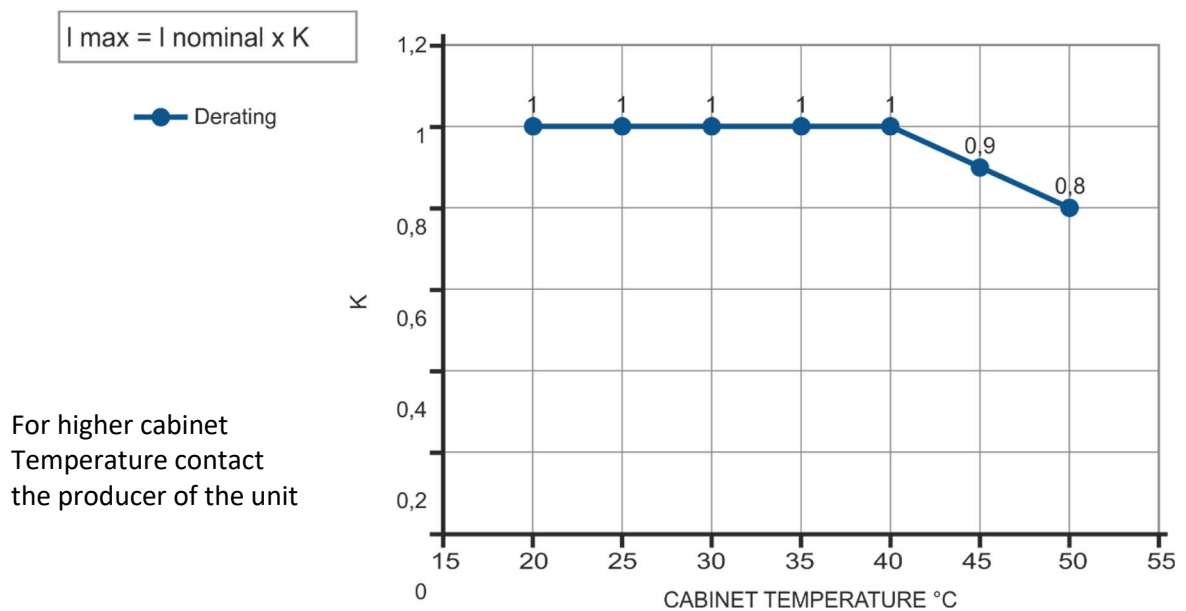

## 7. Installation

Before to install, make sure that the Thyristor unit have not damages.

If the product has a fault, please contact the dealer from which you purchased the product. Verify that the product is the same thing as ordered.

The Thyristor unit must be always mounted in vertical position to improve air cooling on heat-sink.

Maintain the minimum distances in vertical and in horizontal as represented.

When more unit has mounted inside the cabinet maintain the air circulation like represented in figure. Sometimes is necessary installing a fan to have better air circulation.

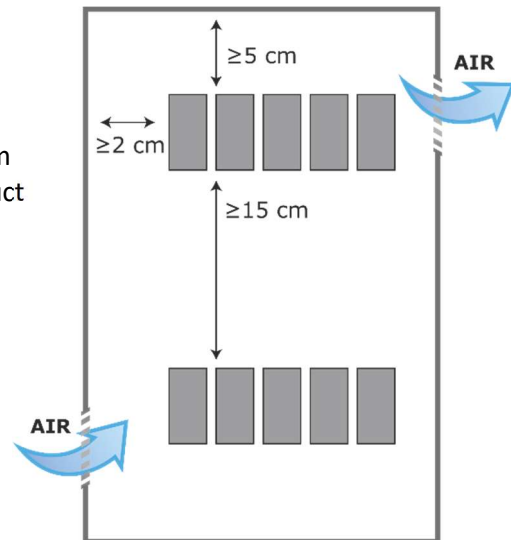

### 7.1. Dimensions and weight

	Width	Height	Depth	Weight
Relay S 2PH 60-90A (SR15)	93 mm	273 mm	170 mm	3.4 kg
Relay S 2PH 120-210A (SR16)	186 mm	273 mm	170 mm	7 kg

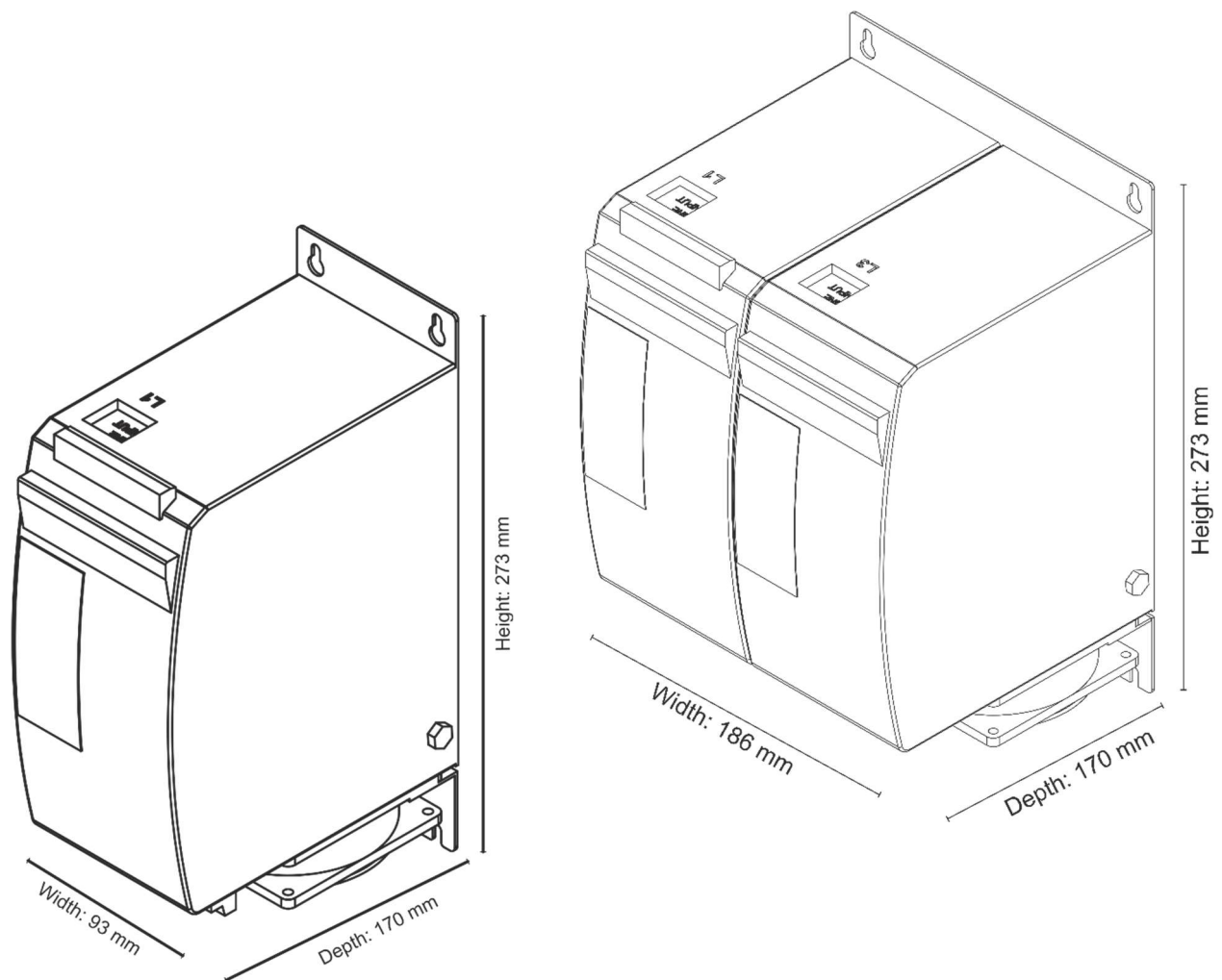

## 7.2. Fixing holes

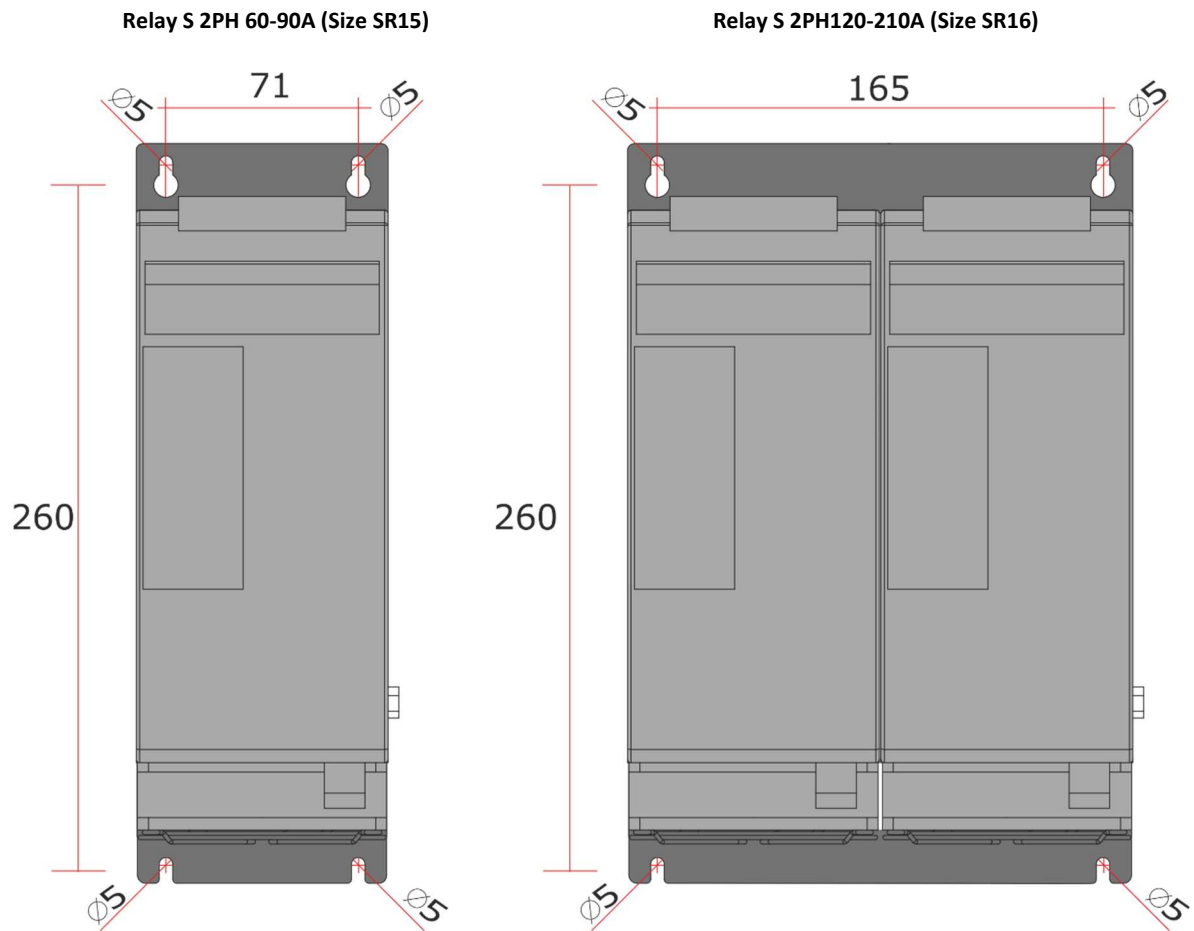

## 8. Wiring instructions

The Thyristor unit could be susceptible to interferences lost by near equipments or by the power supply, for this reason in accord to the fundamental practices rules is opportune take some precautions:

- The coil contactor, the relays and other inductive loads must be equipped with opportune RC filter.
- Use shielded bipolar cables for all the input and output signals.
- The signal cables must not be near and parallel to the power cables.
- Local regulations regarding electrical installation should be rigidly observed.

Use copper cables and wires rated for use at 90°C only.

### Power cable torque (suggested)

Type	Connector Type	Torque Lb-in (N-m)	Wire Range mm <sup>2</sup> (AWG)	MAX Current Terminals	Wire Terminals UL Listed (ZMVV)
060 090* 120	Screw M6	70.8 (8.0)	16 (5) 25 (3) 35 (2)	150 A	Fork/Spade Terminal Copper Tube Crimp.Lug
150 180 210	Screw M8	141.6 (16.0)	50 (0) 70 (00) 90 (000)	250 A	Fork/Spade Terminal Copper Tube Crimp.Lug

\*75A for UL

### Cable dimensions of the Command Terminals:

0.5 mm<sup>2</sup> (AWG 18)

### Cable dimensions of the Earth (suggested):

16 mm<sup>2</sup> (AWG 6) up to 120A

25 mm<sup>2</sup> (AWG 4) up to 210A

### 8.1. Terminals Positions 2PH 60-90A Size

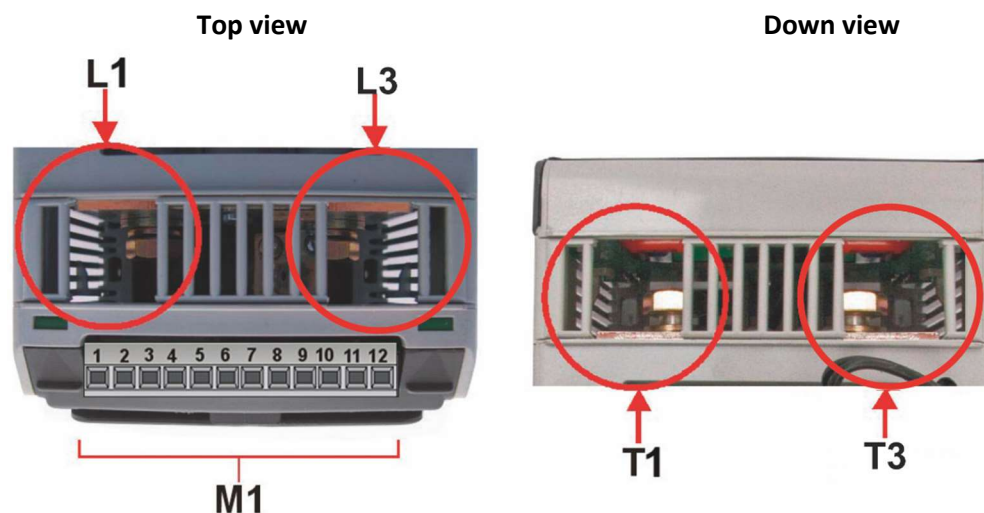

## 8.2. Terminals Positions 2PH 120-210A Size

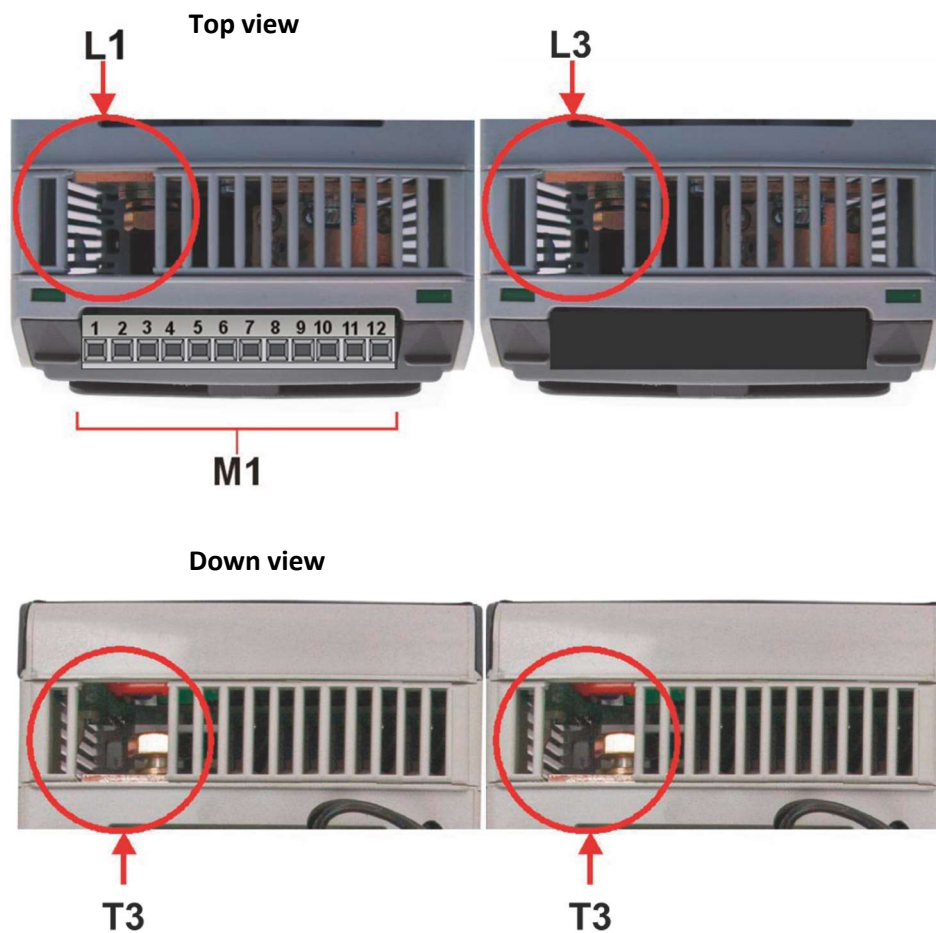

## 8.3. Power Terminals



**Warning:** Before connecting or disconnecting the unit check that power and control cables are isolated from voltage sources.

Terminal	Description
L1	Line Input Phase 1
T1	Load Output Phase 1
L3	Line Input Phase 3
T3	Load Output Phase 3

## 8.4. Command Terminals



**Warning:** Before connecting or disconnecting the unit check that power and control cables are isolated from voltage sources.

### 8.4.1. Terminal block M1 for SSR Input

Terminal M1	Description
1	Not connected
2	Not connected
3	Not connected
4	Not connected
5	Not connected
6	Not connected
7	- Input SSR
8	+ Input SSR
9	Not connected
10	Not connected
11	Fan supply (230V standard, 115V option, - 24Vdc option)
12	Fan supply (230V standard, 115V option, + 24Vdc option)

### 8.4.2. Terminal block M1 for Analog Input or SSR input with HB

Terminal M1	Description
1	Aux - Voltage Supply for electronic boards 24V ac/dc
2	Aux - Voltage Supply for electronic boards 24V ac/dc
3	- Cal Ext. 12/24Vdc
4	+ Cal Ext. 12/24Vdc
5	C -Common contact relay alarm output (see HB Alarm contact for config.)
6	NC\NO -Normally Close\Open contact alarm relay output (see HB Alarm contact for config.)
7	- Control Input (SSR/0-10Vdc/4-20mA)
8	+ Control Input (SSR/0-10Vdc/4-20mA)
9	Not connected
10	Not connected
11	Fan supply (230V standard, 115V option, - 24Vdc option, from 90 to 210A)
12	Fan supply (230V standard, 115V option, + 24Vdc option, from 90 to 210A)



### 8.5. Connection Diagram for 3 phases (control on 2 phases) from 60 to 90A



**Caution:** this procedure must be performed only by qualified persons.

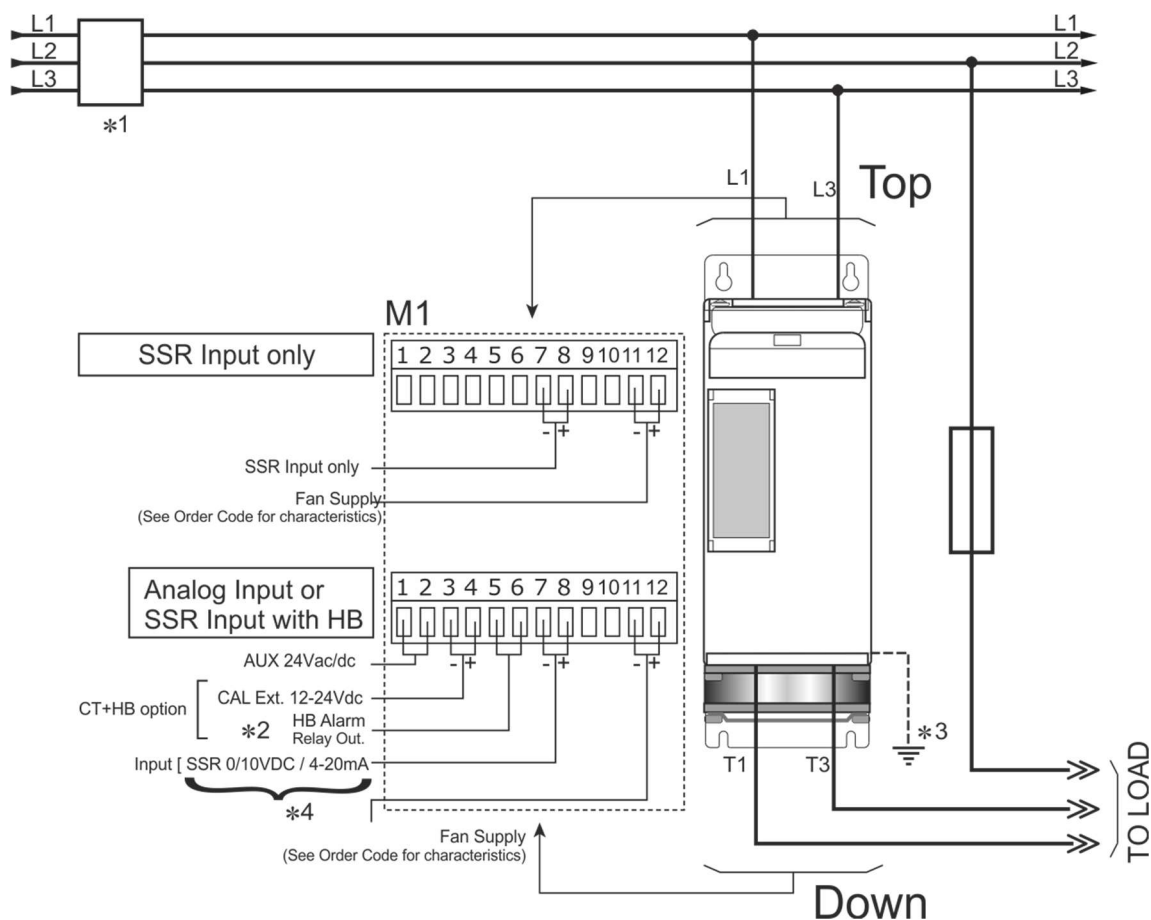

**Note:**

- \*1 A suitable device must ensure that the unit can be electrically isolated from the supply (electromagnetic circuit breaker or by fuse isolator), this allows the qualified people to work in safety.
- \* 2 Only for the HB option See par. "Heater break Alarm and SCR short circuit"
- \* 3 The heat-sink must be connected to the earth.
- \* 4 Only for the Analog Input option, the analog input isn't isolated from Aux Supply a series connection between analog inputs of the units is not possible.  
With AC Aux supply it's not possible connect the zero terminal of Analog Input to the earth.  
With DC Aux supply is not possible to connect the zero of the power supply with the zero of analog input

**LOAD TYPE**

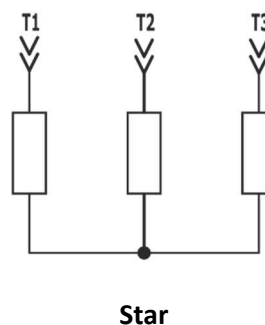
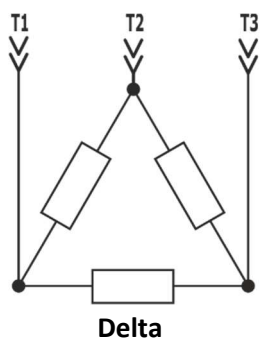

### 8.6. Connection Diagram for 3 phases (control on 2 phases) from 120 to 210A



**Caution:** this procedure must be performed only by qualified persons.

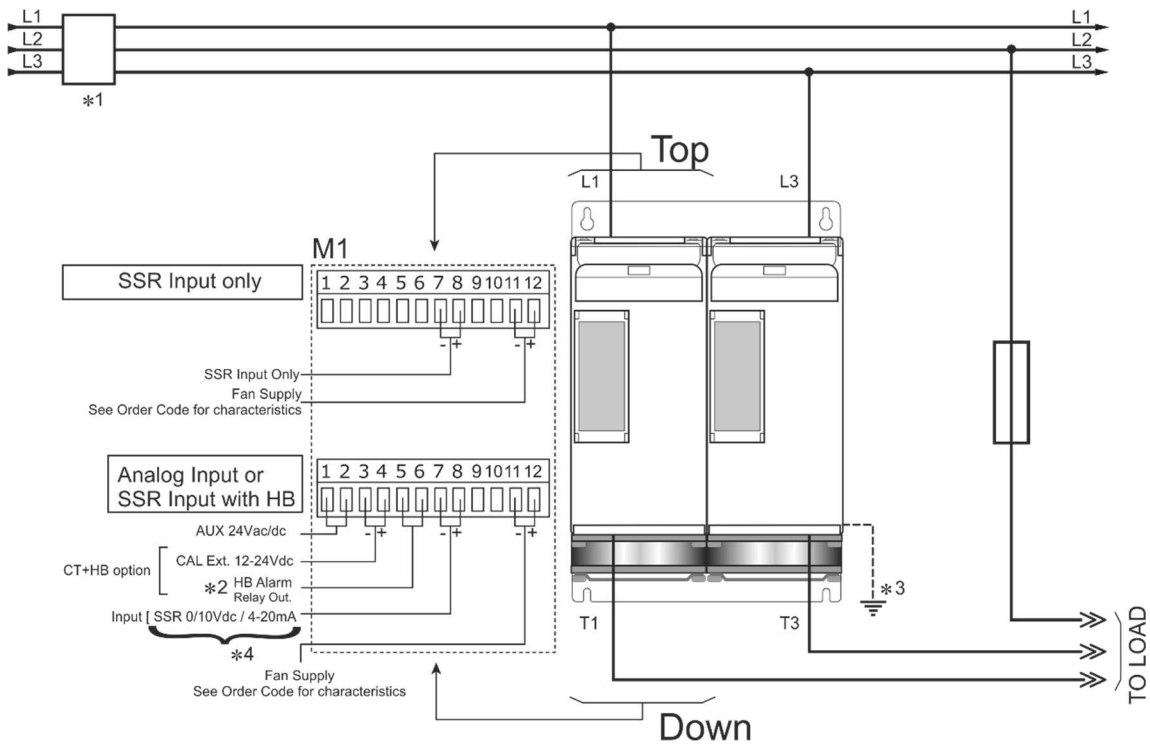





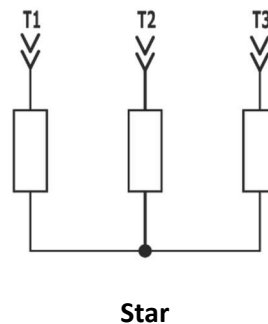
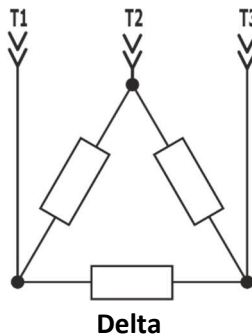

**Note:**

- \*1 A suitable device must ensure that the unit can be electrically isolated from the supply (electromagnetic circuit breaker or by fuse isolator), this allows the qualified people to work in safety.
- \* 2 Only for the HB option See par. "Heater break Alarm and SCR short circuit"
- \* 3 The heat-sink must be connected to the earth.
- \* 4 Only for the Analog Input option, the analog input isn't isolated from Aux Supply a series connection between analog inputs of the units is not possible. With AC Aux supply it's not possible connect the zero terminal of Analog Input to the earth. With DC Aux supply is not possible to connect the zero of the power supply with the zero of analog input

**LOAD TYPE**



## 8.7. Led status and alarms

LED	Status	Description
ON	LED OFF 	Load is NOT powered
	LED ON (Green) 	Load is powered
S.C.	LED OFF 	Load OK
	LED ON (Red) 	SCR short circuit (only with HB option)
	LED Flashing (Red) 	Over Temperature on heat sink
H.B.	LED OFF 	Load OK
	LED ON (Yellow) 	Load Fault (only with HB option)



## 9. Heater Break alarm and SCR short circuit (HB Option only)



**Caution:** to work properly the load must be powered at least about 160msec.

The Heater Break circuit read the load current with an Internal current transformer (C.T.). Minimum current is 10% of the current transformer size. If load current is below this value the Heater Break Alarm doesn't work properly.

### 9.1. Heater break Calibration procedure

An automatic function sets the Heater Break Alarm.

The auto setting function can be activated using the "CAL" button on front unit, or supply with 12-24Vdc the digital input "Cal Ext." (See Connection Diagram).

The Heater Break calibration procedure is performed in this way:

- The Unit gives the maximum voltage output
- All LEDs are on, this means that calibration procedure is active
- The current value is stored in memory
- After about 15 second the unit comes back to the initial situation

If load current decreases for partial or total load failure (sensitivity 20%) the yellow LED HB become ON and alarm relay change status.

If the unit is still in conduction with no input signal (LED green OFF) it means that there is a short circuit on thyristors and red LED (SC) become ON.

If the load has been changed the Heater Break calibration procedure must be done again.

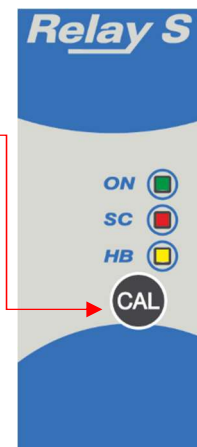

## 9.2. HB Alarm contact

The Relay S unit with HB option (if available), is supplied with Heater Break alarm contact normally opened (NO):

- In normal conditions (without alarm) and with auxiliary power supply, the contact to the terminals has opened (relay coil energized).
- In alarm condition or without auxiliary power supply the contact to the terminals is closed (relay coil not energized).

If you wish to change the alarm contact open the cover of the Master module (first on the left with terminal block) and set the jumper as shown in the next page, **don't set the other jumpers with factory settings.**



**Warning:** Before operate, be sure that power and control cables are isolated from voltage sources.

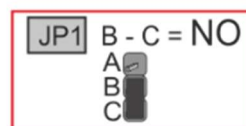
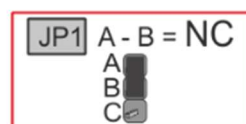
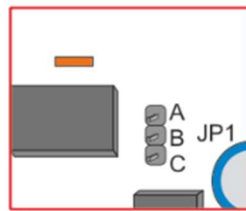
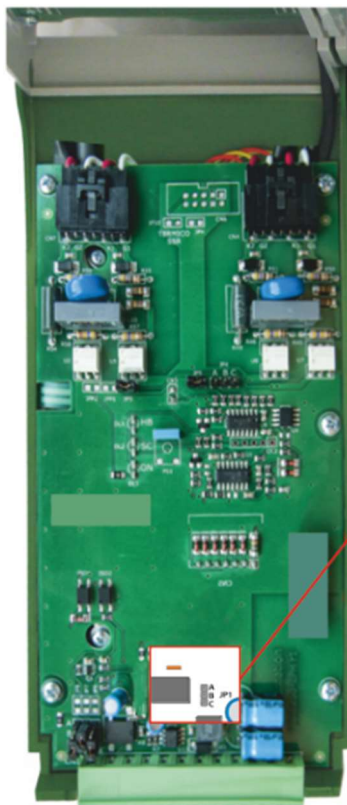
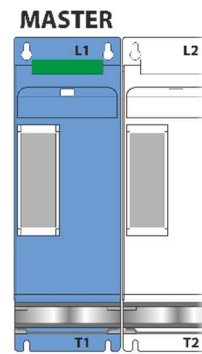

## 10. Input setting

The input type is already configured in line with customer requirements that are defined in the Order Code. However, if you wish to change the input type (ex. from 0÷10V to 4÷20mA) set the jumpers as below represented and then do the "Input calibration procedure" Open the cover of the Master module (first on the left with terminal block) and set the jumper as shown, don't set the other jumpers with factory settings not shown.

**Important: The analog input isn't isolated from Aux Supply. The series connection between analog inputs of the units is not possible. With AC Aux supply it's not possible connect the zero terminal of analog input to the earth. With DC Aux supply is not possible to connect the zero of the power supply with the zero of analog input.**



**Warning:** Before operate, be sure that power and control cables are isolated from voltage sources.

**SSR**

A	JP2	A-B
B	JP3	B-C
C	JP6	A-B

**0-10 Vdc**

A	JP2	B-C
B	JP3	B-C
C	JP6	B-C

**4-20 mA**

A	JP2	B-C
B	JP3	A-B
C	JP6	B-C

---

**nur SSR**

A	JP8	gebrückt
B	JP9	gebrückt

**MASTER**

There are two type of PCB board, for SSR Only Version board the other jumpers are not mounted on PCB.

### 10.1. Input calibration procedure



**Warning!** this procedure can be done just by specialized personnel

This procedure is needed only if you change the input type.

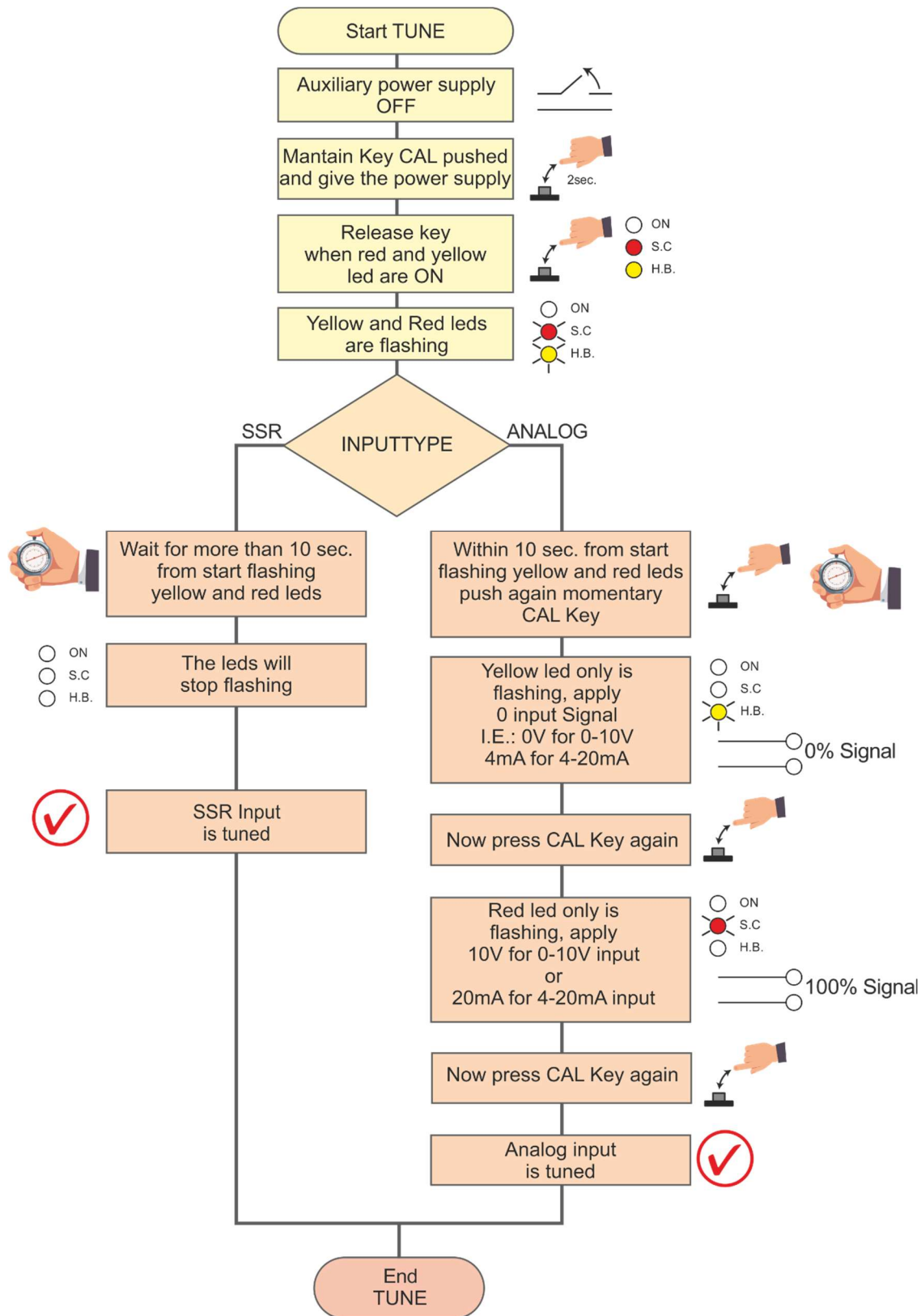

## 11. Firing type

Choose a correct firing type allows to optimize the thyristor unit for the installed load. The firing type has already configured in line with customer requirements, Zero Crossing for SSR input and Burst firing for Analog Input.



**Caution:** this procedure must be performed only by qualified persons.

### 11.1. Zero Crossing (ZC) with SSR Input

ZC firing mode is used with Logic Output from temperature controllers and the Thyristor operates like a contactor.

The Cycle time is performed by temperature controller. ZC minimizes interferences because the Thyristor unit switches ON-OFF at zero voltage.

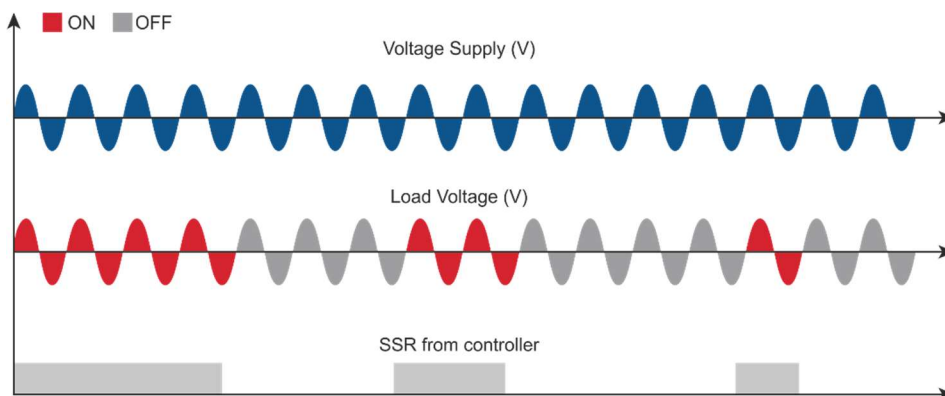

### 11.2. Burst Firing (BF) with Analog Input

The Burst Firing is similar to the Single Cycle, but consecutive cycles ON are selectable between 1 and 255, with input signal equal at 50%. When is specified 1 the firing type is Single Cycle. Burst Firing is a method zero crossing that it reduces the electromagnetic interferences because the thyristor switches at zero voltage crossing.

The example show the Burst Firing with Burst cycles = 4

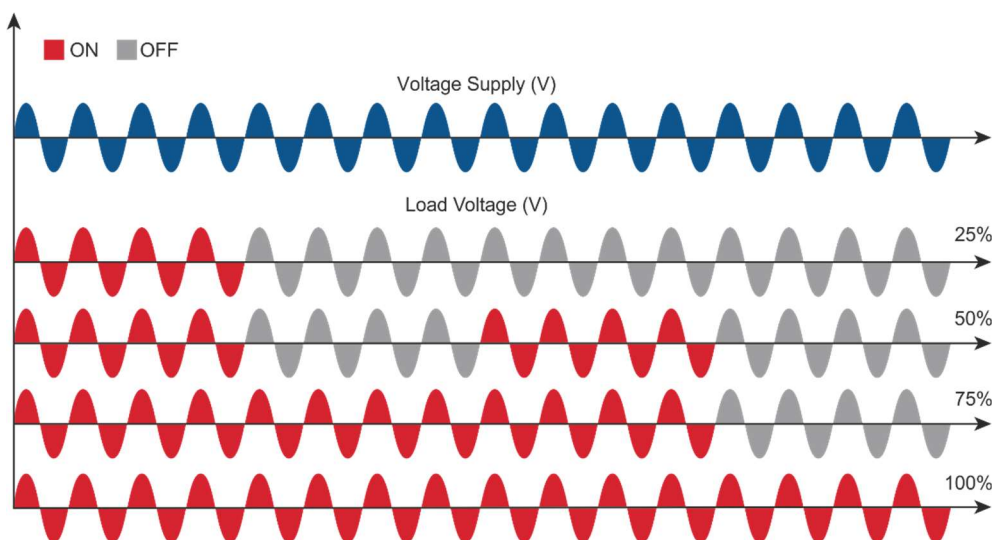

### 11.3. Burst Firing settings

The Burst Firing cycles is already configured in line with customer requirements that are defined in the Order Code. However, if you wish to change the Burst Firing cycles (es. from 4 to 8) set the jumpers as below represented:



**Warning:** Before operate, be sure that power and control cables are isolated from voltage sources.

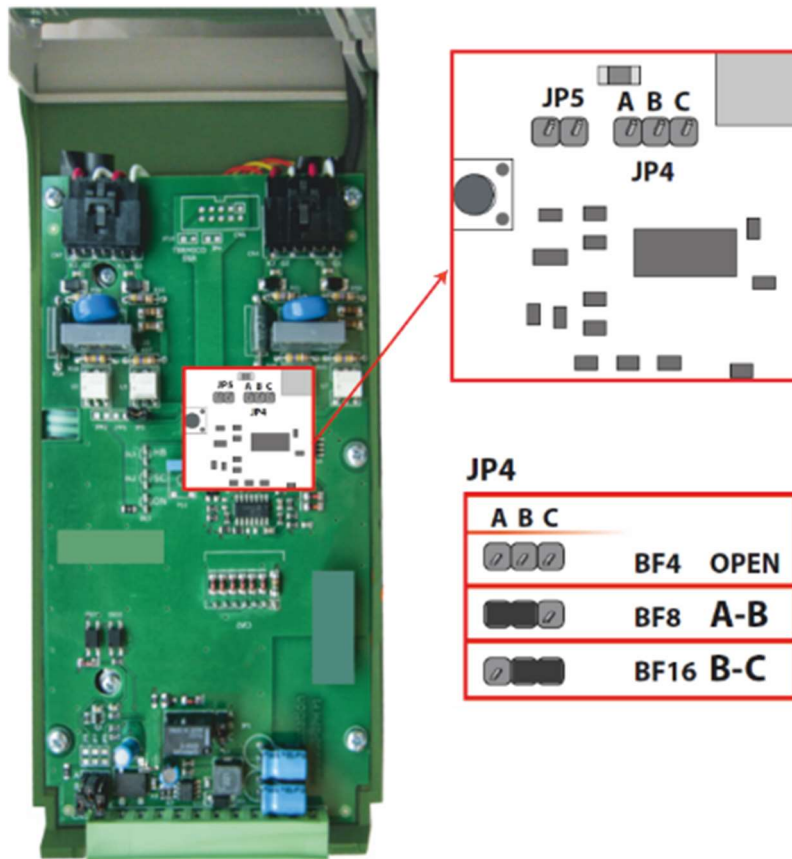



## 12. Internal Fuse

The thyristor unit have internal fuse extrarapid at low  $I^2t$  for the thyristor protection of against the short-circuits.

The Fuses must have  $I^2t$  20% less than thyristor's  $I^2t$ . The warranty of thyristor is null if no proper fuses are used.

Type	Fuse Code Spare Part	Current (ARMS)	Vac	FUSE I2T value Suggested A2s (at500V)*	FUSE I2T value Suggested A2s (at660V)
060	2 x 50 073 06.100	2 x 100	660	8680	12400
060 (only UL)	L220971J	100	660	3998	6150 (690V)
075 (only UL)	L220971J	100	660	3998	6150 (690V)
090	2 x 50 073 06.100	2 x 100	660	8680	12400
120	20 559 20.180	180	660	14280	20400
150	20 559 20.200	200	660	17500	25000
180	20 559 20.250	250	660	30800	44000
210	20 559 20.315	315	660	53900	77000

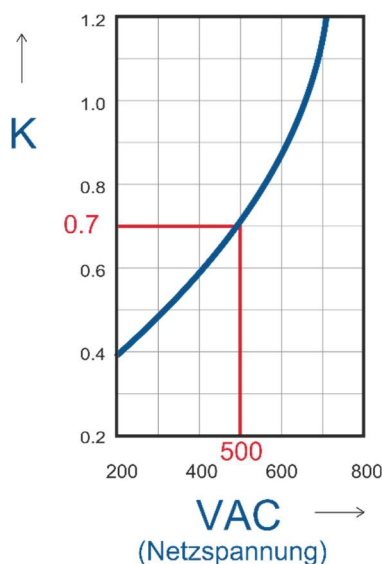

\*I2T are multiplied for K value in function of Vac at 500V K is equal to 0,7 (ex:12400 X 0,7 = 8680).  
At 660Vac K is equal to 1.



**Caution:** High speed fuses are used only for the thyristor protection and can not be used to protect the installation.



**Caution:** The warranty of thyristor is null if no proper fuses are used. See tab.



**Warning:** When it is supply, the Thyristor unit is subject to dangerous voltage, don't open the Fuse-holder module and don't touch the electric equipments.





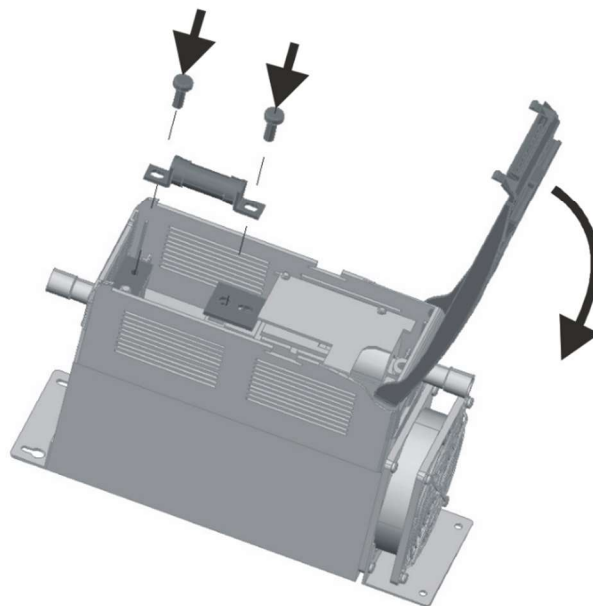
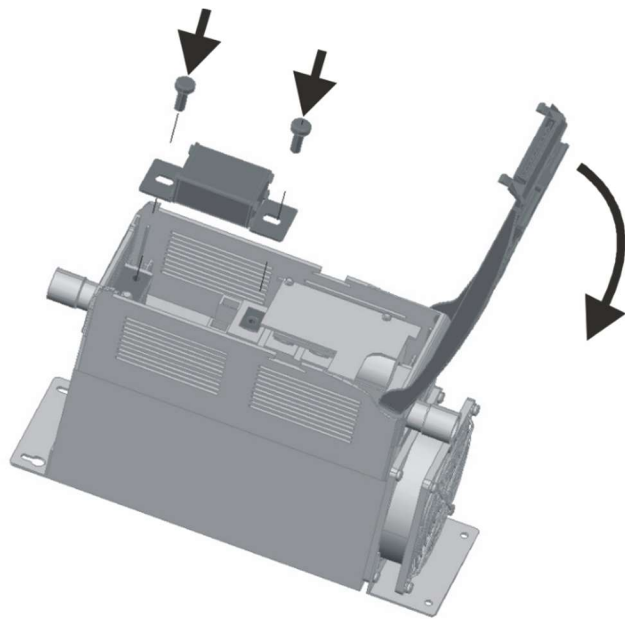

## 12.1. Fuses Replacement

Open the cover and remove the screws.



## 13. Trouble shooting

Small problems sometimes can be solved locally with the help of the below tab of trouble shooting. If you don't succeed, contact us or your nearest distributor.

Symptom	Indication on front unit	Possible reasons of the symptom	Actions
Load current doesn't flow	Green LED (ON) light OFF 	<ul style="list-style-type: none"> <li>No Auxiliary Voltage</li> <li>No input signal</li> <li>Reversed polarities of input signal</li> </ul>	<ul style="list-style-type: none"> <li>Give auxiliary voltage supply (See Connection Diagram)</li> <li>Provide to give input signal</li> <li>Reverse the input signal polarity</li> </ul>
	Green LED (ON) light ON 	<ul style="list-style-type: none"> <li>Fuse failure</li> <li>Load connection interruption</li> <li>Load failure: The yellow led  (HB) is light on (with HB option)</li> <li>Thyristor fault: The red led (SC) is light on (with HB option) </li> </ul>	<ul style="list-style-type: none"> <li>Change the fuse</li> <li>Check the wiring</li> <li>Check the load</li> <li>Change the thyristor module</li> </ul>
Load current flow also without input signal	Red LED (SC) light ON 	<ul style="list-style-type: none"> <li>Wrong wiring</li> <li>SCR short circuit</li> </ul>	<ul style="list-style-type: none"> <li>Check the wiring</li> <li>Change the thyristor module</li> </ul>
Current flows at nominal value but Yellow LED (HB/SC) is light on	Yellow LED (HB) light ON  or Red LED (SC) light ON 	<ul style="list-style-type: none"> <li>HB circuit not tuned</li> <li>Current transformers not properly wired</li> </ul>	<ul style="list-style-type: none"> <li>Make HB calibration procedure</li> <li>Check current transformers wiring</li> </ul>
Thyristor unit doesn't work properly		<ul style="list-style-type: none"> <li>Auxiliary voltage supply out of limits</li> <li>Wrong input signal selection</li> <li>Wrong input signal calibration (out of range)</li> </ul>	<ul style="list-style-type: none"> <li>Verify the auxiliary voltage supply</li> <li>Control input signal setting</li> <li>Check input setting</li> </ul>

