

PMA Prozeß- und Maschinen-Automation GmbH



KS vario BT Operating terminal for modular controller system



**Operating manual
9499-040-75911
valid from 8464**

©PMA Prozeß- und Maschinen-Automation GmbH 2008. Printed in Germany

All rights of documentation are reserved by PMA Prozeß- und Maschinen-Automation GmbH. No part of this document may be reproduced or published in any form or by any means without prior written permission by PMA Prozeß- und Maschinen-Automation GmbH.

PMA Prozeß- und Maschinen-Automation GmbH is entitled to make changes of the described product or of the documentation without notice, if these changes are made for reasons of reliability or quality assurance, or in the interest of technical progress.

PMA Prozeß- und Maschinen-Automation GmbH
P.O. Box 31 02 29
D 34058 Kassel
Germany

BlueControl[®] is a registered trademark of PMA GmbH

Limitation of warranty

The content of this documentation was prepared and checked with utmost care. However, PMA Prozeß- und Maschinen-Automation GmbH refuses any liability for damage which may result from errors in the documentation. In particular, descriptions and technical data cannot be considered as warranted features in the legal sense.

Kassel, 24.06.2008

Content

General notes..... 5

Safety and precautionary measures..... 5

Commissioning/shut-down..... 6

Unpacking the instrument..... 6

Electrical connections..... 6

Power supply..... 6

Bus cables 6

Connections and mounting KSvarioBT 8

Connections and mounting KsvarioBT3 9

Connections and mounting KsvarioBT12 10

Cable for connection of KSvarioBT/3/12 COM1 (RS232) to KS vario controller module engineering port 15

KSvarioBT COM3 (RS485) connecting cable to KS vario Modbus coupler..... 16

KSvarioBT12 COM4 (RS485) connecting cable to KS vario Modbus coupler..... 16

KsvarioBT3 COM1 (RS485) connecting cable to KS vario Modbus coupler 17

Operator interface 18

 Fundamentals 18

Commissioning and basic configuration of a new operating terminal..... 19

 KS vario configuration..... 19

 KS vario BT configuration 20

Basic principles of operation 21

 The survey page (only KsvarioBT and KsvarioBT3)..... 21

 The survey page (only KsvarioBT12) 22

 The controller page 23

 The page for controller group operation..... 24

 The trend page..... 25

 Limit values..... 26

 Alarm screen..... 27

Parameter setting and special dialogues 28

 The parameter page 28

 Self-tuning..... 29

 Group operation 30

 Copying settings 31

Recipes.....32
Passwords.....33
***Technical data* 34**

General notes

KS vario BT was designed to realize a de-central terminal for KS vario multi-channel controller operation and monitoring. It can be used for operation of the bussable KS vario without an additional automation system. The standard version permits operation of up to 30 control loops connected to a terminal.

These operating instructions are valid for KS vario BT versions with order number:

KSVC-111-02151 (KsvarioBT)
KSVC-111-02351 (KsvarioBT3)
KSVC-111-02651 (KsvarioBT12)

For versions, see data sheet.

Safety and precautionary measures

This instrument was built and tested in accordance with VDE 0411 / EN 61010-1 and was shipped in safe condition. Protection class is IP65 (front panel) or IP20 (rear).

The instrument complies with European guideline 89/336/EEC (EMC) and is provided with the CE marking.

To maintain this condition and to ensure safe operation, the user must follow the hints and warnings given in these operating instructions and in the safety hints.

The overall equipment of machines / systems intended for the European market must comply with EN 60 204 part 1/85 (identical with VDE 0113 part 1 / 02.86).

With machines / systems intended for exportation into other than European countries, the applicable national safety regulations must be taken into account.



As compliance with the safety regulation is beyond our influence, liability for damage resulting from failure to comply with one or several of these regulations is precluded.

The list of applicable safety regulations cannot be comprehensive (German and foreign machine regulations). Failure to include one of these regulations in the list does not mean that is not applicable.

Repair and maintenance work may be done only by persons who are recognized specialists in the sense of the regulations: VDE standards, law on instrument safety, trade association regulations for accident prevention.

The instrument may be operated only by qualified persons. Operation without impairment of its safety is possible only within the permissible environmental conditions (see data sheet).

The instrument is provided exclusively for application as an operating terminal for measurement and control instrumentation in technical installations.

Commissioning/shut-down

Unpacking the instrument

Check, if the consignment is correct and complete. Inspect the instrument for damage due to improper handling during transport and storage.



If the instrument is damaged to an extent that safe operation cannot reasonably be expected, the instrument must not be taken into operation.



Before installation/dismounting of the instrument, or before mounting or dismounting of connectors on the instrument, KS vario BT must be disconnected completely from the supply voltage, i.e. the instrument must be de-energized.

Electrical connections

The electrical connections must be in compliance with the national standards (e.g. VDE 0100 in Germany).

For improved interference suppression, the signal and data lines must be kept separate from power supply cables. Before fitting or removing connectors on KS vario BT, the supply voltage must be switched off completely.

Power supply

KS vario BT requires an external supply voltage rating of 24V DC (-15%/+20%), max. power consumption 20W (KSvarioBT3 max. 12W, KSvarioBT12 max. 60W). Connection for KsvarioBT/BT12 is via a 3-pole terminal (e.g. Phoenix type: FRONT-MSTB, 2,5/3-ST-5,08). For the KsvarioBT3 a 2-pole terminal have to be used (e.g. Phoenix type: FRONT-MC 1,5/ 2-ST-3,81).

Note the polarity.

Bus cables

For the bus cable, we recommend using a screened data cable. One end of the screening must be connected to KS vario BT. The D-connectors / D-sockets of KS vario BT are connected conductantly with the housing.

Connecting diagram for cable screening

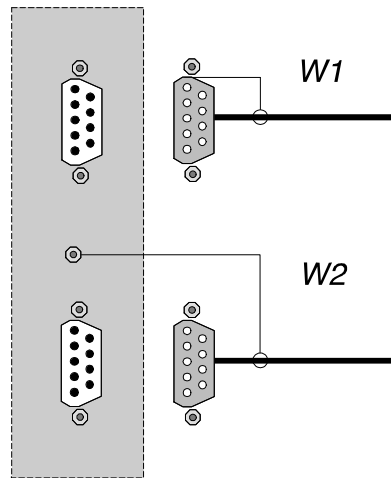

The connection of KS vario BT to the terminal provided for this purpose should be of low resistance. The cable for connection to PE should be as short as possible!

Connections and mounting KSvarioBT

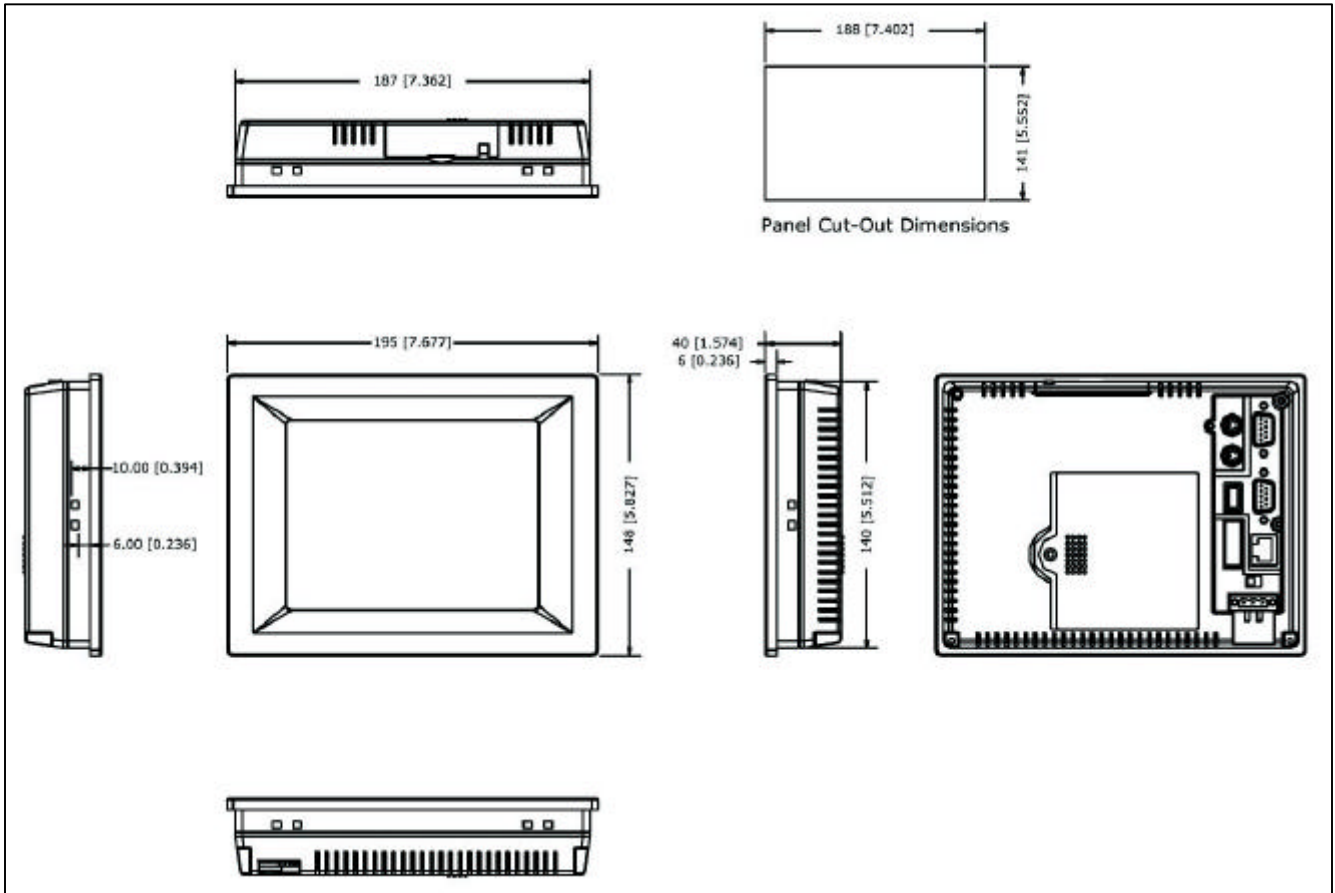

Fig. 1: KS vario BT dimension drawing, all dimensions in mm [inch]

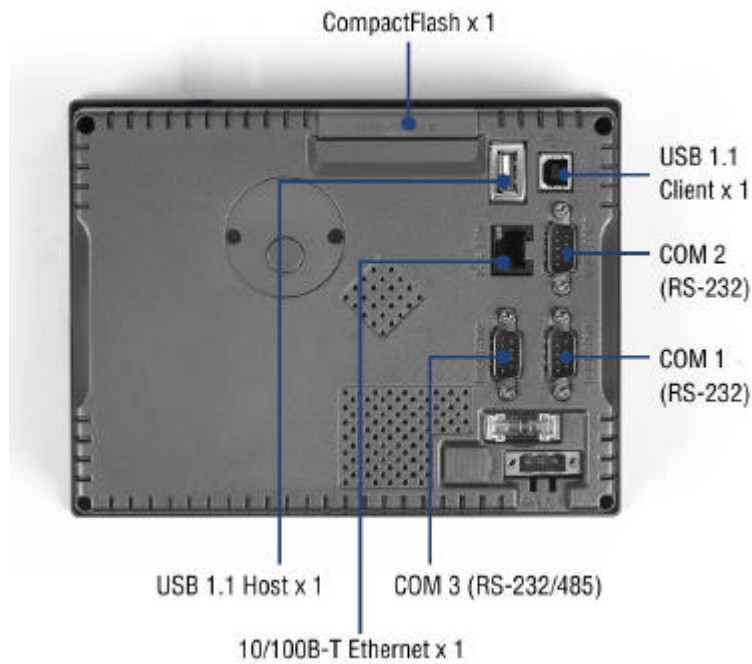

Fig. 2 KS vario BT rear panel

Connections and mounting KsvaroBT3

Unit: mm

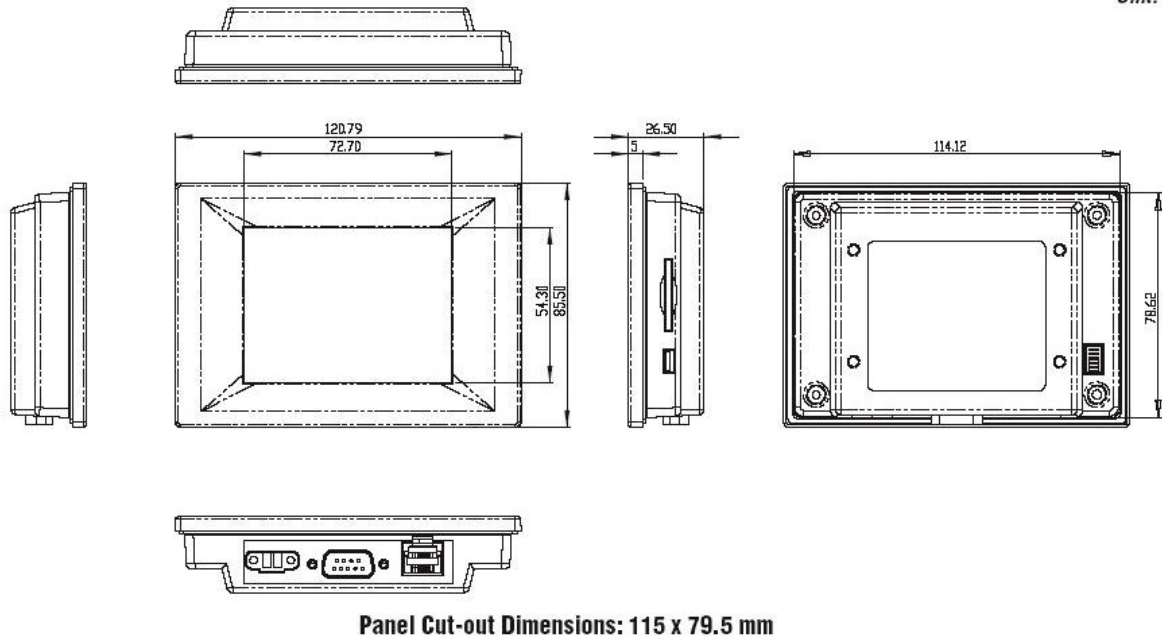

Fig. 3: KS vario BT3 dimension drawing, all dimensions in mm

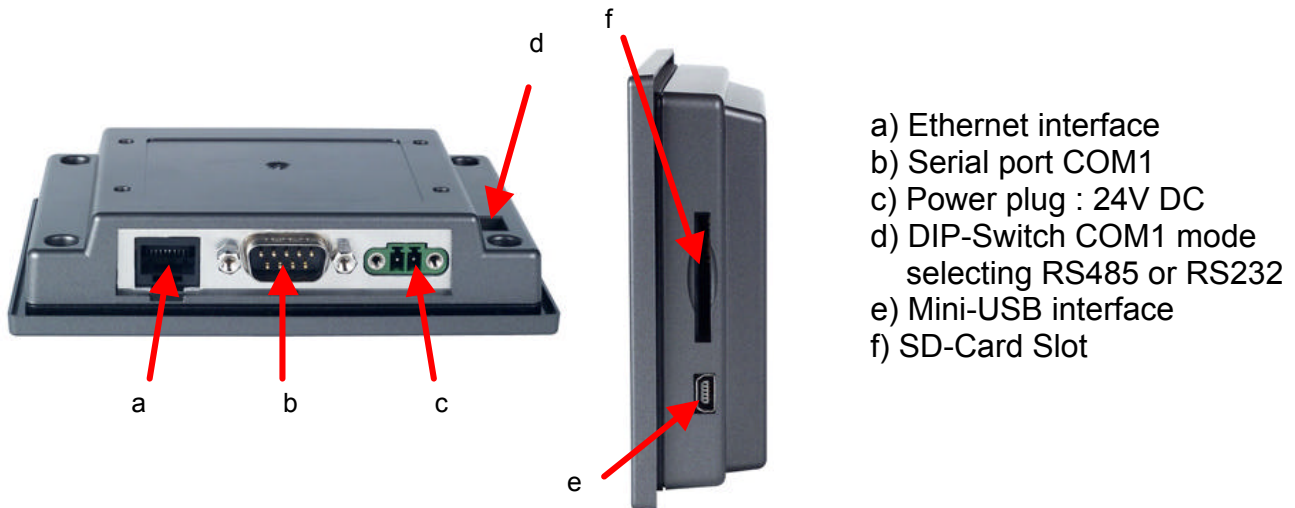

Fig. 4 KS vario BT3 I/O

Connections and mounting KsvarioBT12

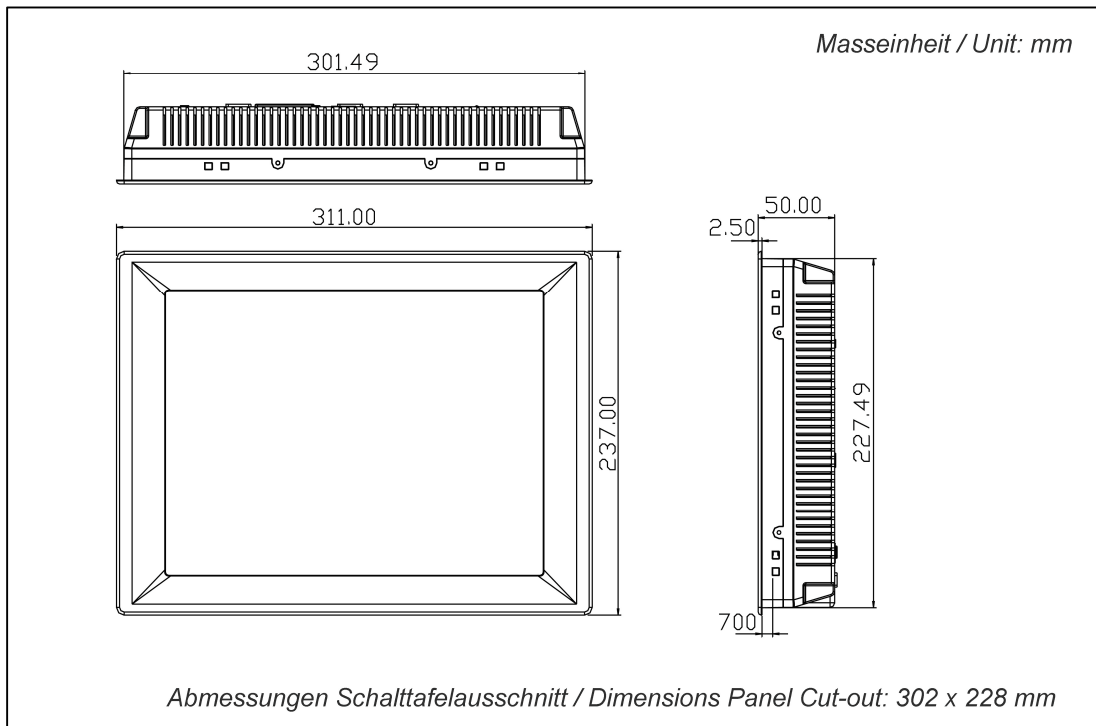

Fig. 5: KS vario BT 12 dimension drawing, all dimensions in mm

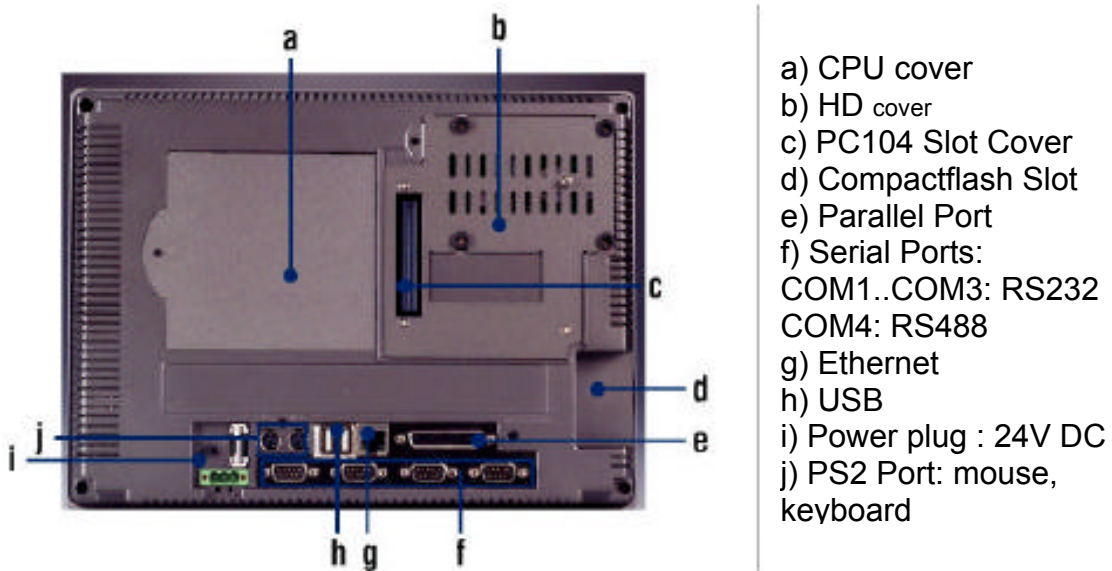

Fig. 6 KS vario BT 12 rear panel

Hints for connection

Power supply

KS vario BT requires an external power supply rating of 24V DC (-15%/+20%), max. power consumption 20W. Connection is via a 3-pole terminal (e.g. Phoenix type: FRONT-MSTB, 2,5/3-ST-5,08)

KS vario BT3 requires an external power supply rating of 24V DC (-65%/+15%), max. power consumption 10W. Connection is via a 3-pole terminal (e.g. Phoenix type: FRONT-MC 1,5/ 2-ST-3,81).

KS vario BT12 requires an external power supply rating of 24V DC (-15%/+20%), max. power consumption 60W. Connection is via a 3-pole terminal (e.g. Phoenix type: FRONT-MSTB, 2,5/3-ST-5,08)



Ensure correct connection to the protective earth system using a protective earth conductor.

KsvaroBT/KSvaroBT12



Pin 1: + 24VDC
Pin 2: Gnd
PIN 3: PF

KsvaroBT3

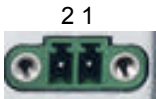

Pin 1: Gnd
Pin 2: + 24VDC

Fuse

The supply voltage is protected by means of a fuse in the terminal. A fine-wire fuse with the following rating is used:

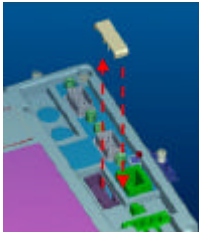

KsvaroBT12



The KsvaroBT3 uses an internal micro fuse (125V/5A, quick-acting). It's not possible for the enduser to change the fuse!



For fuse replacement (**only** KsvaroBT and KsvaroBT12), proceed as follows:

- Remove the fuse cover
- Replace the fuse
- Re-fit the cover



Do not replace the fuse before removing the cause for blowing. Only spare fuses with identical rating should be used!

COM1 RS232 interface (KsvaroBT/BT3/BT12)

RS232 interface, 9-pole D-SUB connector with the following pin allocation:

Pin no.	Description	Signal
1	DCD	
2	RXD	RS232 receive data
3	TXD	RS232 send data
4	DTR	
5	GND	GND
6	DSR	
7	RTS	
8	CTS	
9	RI	



The KsvaroBT3 COM1 mode DIP switches have to be set for RS232 mode:

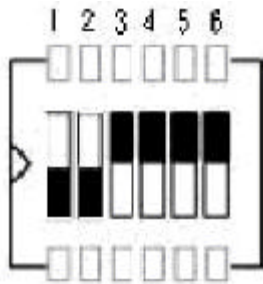

S1 S2 S3 S4 S5 S6
ON ON OFF OFF OFF OFF

COM3 RS485 bus interface (only KsvaroBT)

RS485 interface, 9-pole D-SUB connector with the following pin allocation:

Pin no.	Description	Signal
1	DATA-	Inverted data signal
2	n.c.	-----
3	n.c.	-----
4	DATA+	Data signal
5	GND	GND
6	n.c.	-----
7	n.c.	-----
8	n.c.	-----
9	n.c.	-----

COM4 RS485 bus interface (only KsvaroBT12)

RS485 interface, 9-pole D-SUB connector with the following pin allocation:

Pin no.	Description	Signal
1	DATA-	Inverted data signal
2	DATA+	Data signal
3	n.c.	-----
4	n.c.	-----
5	GND	GND
6	n.c.	-----
7	n.c.	-----
8	n.c.	-----
9	n.c.	-----

 **n.c. Connections to unused signals are not permissible!**

COM1 RS485 mode bus interface (only KsvarioBT3)

RS485 interface, 9-pole D-SUB connector with the following pin allocation:

Pin no.	Description	Signal
1	n.c.	-----
2	DATA+	Data signal
3	DATA-	Inverted data signal
4	n.c.	-----
5	GND	GND
6	n.c.	-----
7	n.c.	-----
8	n.c.	-----
9	n.c.	-----



The KsvarioBT3 COM1 mode DIP switches have to be set for RS485 mode:

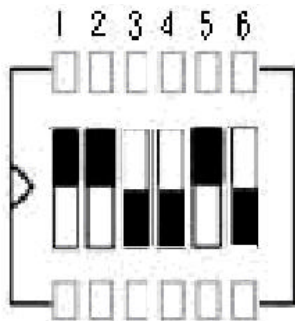

S1 S2 S3 S4 S5 S6
OFF OFF ON ON OFF ON

Cable for connection of KSvarioBT/3/12 COM1 (RS232) to KS vario controller module engineering port

KSvarioBT

-9-pole Sub-D socket with metal cover

Belegung:

pin 1: n.c.
pin 2: TxD
pin 3: RxD
pin 4: n.c.
pin 5: Gnd
pin 6: n.c.
pin 7: n.c.
pin 8: n.c.
pin 9: n.c.

Screening connected to connector housing

Ferrite cable cores suitable for cable diameter, fixed at both cable ends

KSvario

3-pole stereo jack d=3,5 mm, with plastic cover

Pin allocation:

pin 1: TxD
pin 2: RxD
pin 3: GND

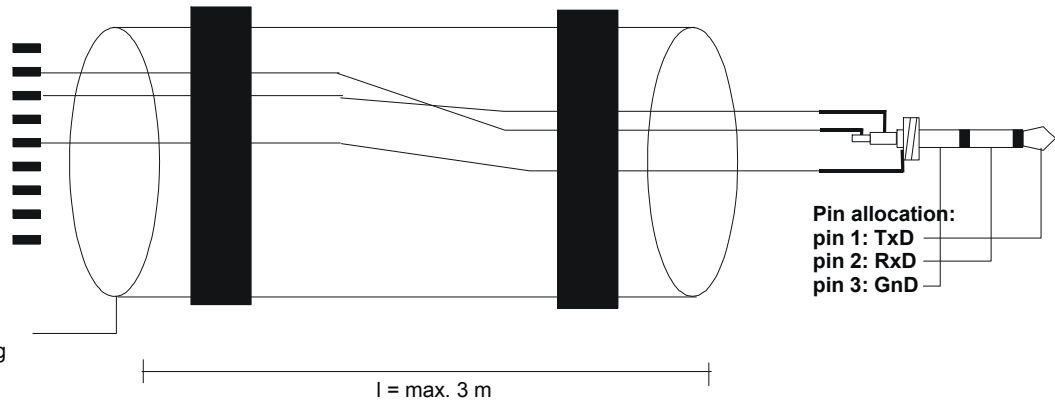

Min. 3-pole, screened cable,
One end of screening connected

KSvarioBT COM3 (RS485) connecting cable to KS vario Modbus coupler

KSvarioBT

9-pole sub-D socket with metal cover

Pin allocation:
 pin 1: Data-A
 pin 2: n.c.
 pin 3: n.c.
 pin 4: Data-B
 pin 5: n.c.
 pin 6: n.c.
 pin 7: n.c.
 pin 8: n.c.
 pin 9: n.c.

Screening connected to connector housing

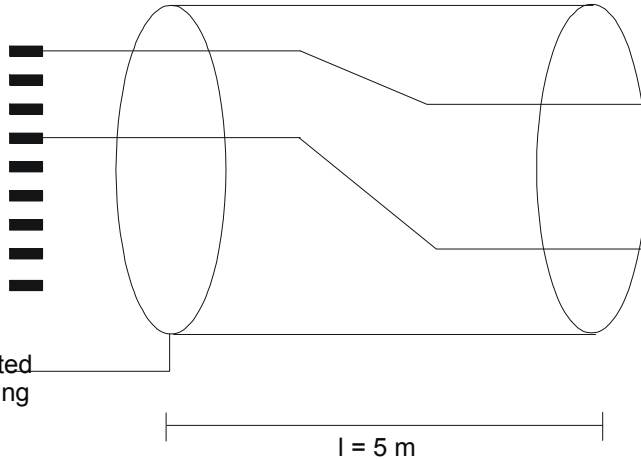

Min. 2-pole, screened cable,
 One end of screening connected

KSvario

9-pole sub-D connector with metal cover

Pin allocation:
 pin 1: n.c.
 pin 2: n.c.
 pin 3: Data-A
 pin 4: n.c.
 pin 5: n.c.
 pin 6: n.c.
 pin 7: n.c.
 pin 8: Data-B.
 pin 9: n.c.

KSvarioBT12 COM4 (RS485) connecting cable to KS vario Modbus coupler

KSvarioBT12

9 pol. Sub-D socket with metal cover

Pin allocation:
 pin 1: Data-
 pin 2: Data+
 pin 3: n.c.
 pin 4: n.c.
 pin 5: n.c.
 pin 6: n.c.
 pin 7: n.c.
 pin 8: n.c.
 pin 9: n.c.

Screening connected to connector housing

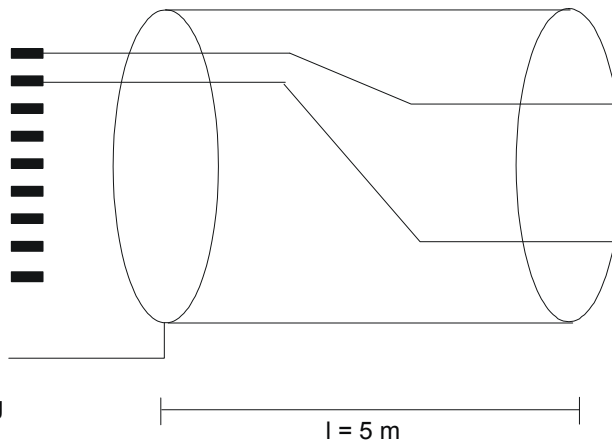

Min. 2-pole, screened cable.
 One end of screening connected

KSvario

9 pol. Sub-D connector with metal cover

Pin allocation:
 pin 1: n.c.
 pin 2: n.c.
 pin 3: Data-A
 pin 4: n.c.
 pin 5: n.c.
 pin 6: n.c.
 pin 7: n.c.
 pin 8: Data-B.
 pin 9: n.c.

KsvaroBT3 COM1 (RS485) connecting cable to KS vario Modbus coupler

KSvaroBT3
9 pol. Sub-D socket
with metal cover

KSvario

9 pol. Sub-D connector
with metal cover

Pin allocation:

pin 1: n.c.
pin 2: Data-B
pin 3: Data-A
pin 4: n.c.
pin 5: n.c.
pin 6: n.c.
pin 7: n.c.
pin 8: n.c.
pin 9: n.c.

Pin allocation:

pin 1: n.c.
pin 2: n.c.
pin 3: Data-A
pin 4: n.c.
pin 5: n.c.
pin 6: n.c.
pin 7: n.c.
pin 8: Data-B.
pin 9: n.c.

Screening
connected to
connector housing

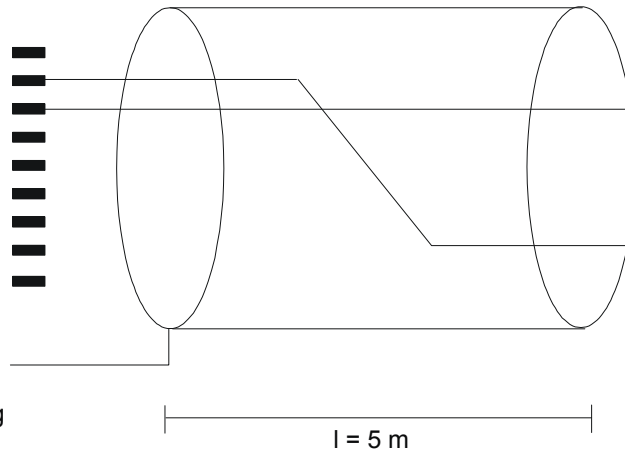

**Min. 3-pole, screened cable.
One end of screening connected**

Operator interface

Fundamentals

The operation consists of dialogue pages which offer an overall survey and other pages which offer detail information on individual control channels.

The three modes for changing operator dialogues are:

1. Exit from the main page by [X].
A menu dialogue based on the workstation with a Windows computer is displayed. The icons on the menu page can be used to open new dialogue pages.
2. Keys for direct selection
Can be used for calling up adjacent operator dialogues directly.
3. Parameter page menu
Access to the parameter setting pages from the main operating page is via a pull-down menu.

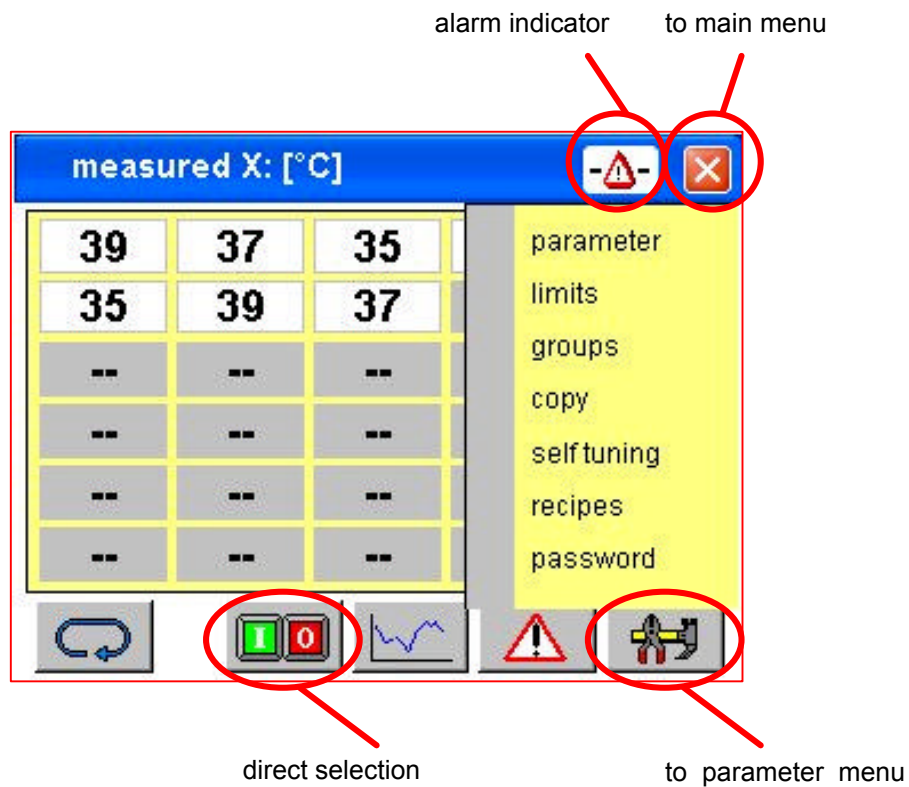

Commissioning and basic configuration of a new operating terminal

KS vario configuration

i At first, configure your KS-Vario by means of the BlueControl® engineering tool.

- With a Modbus version, select Baudrate 38400 and address 1.
- Enter 5ms into field "Modem delay".

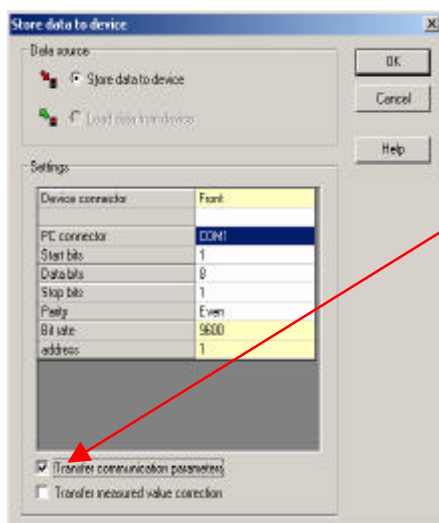
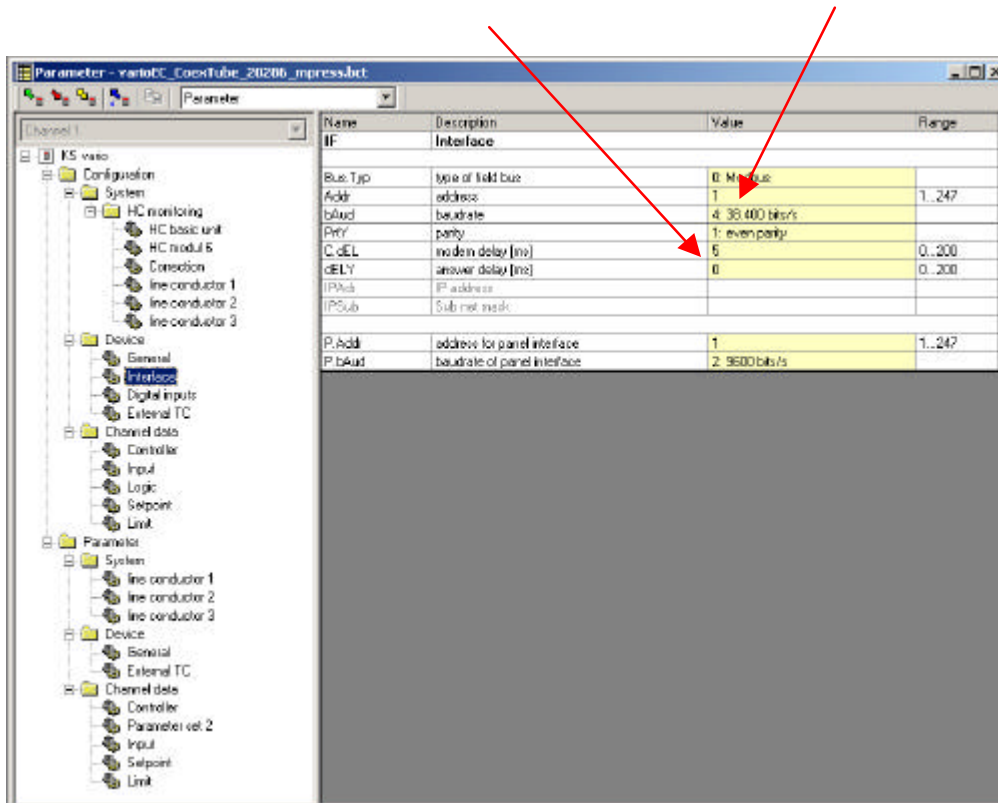

During download from the BlueControl® engineering tool into Ks vario, please, don't forget to transmit also the interface parameters (tick 'Transfer communication parameters').

KS vario BT configuration

Connect the terminal to controller:

KS vario with MODBUS coupler using the appropriate RS 485 cable between KsvaroBT COM RS485 and the connector on the bus coupler

KS vario with other field bus couplers using the relevant RS 232 cable between COM1 and the KS-Vario controller module diagnostic interface.

After starting the terminal, the main operating dialogue is displayed.

Exit from this dialogue is via [X].

Select [Config] on the menu page.

Select [Setup] on the following menu page.

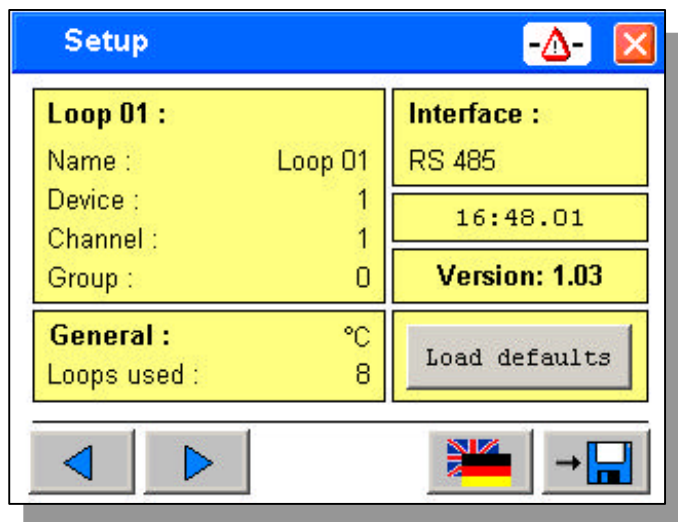

Please, configure in the following order:

- At first, select the interface. RS485 for Modbus interfaces and RS232 for all other interfaces.
- Now, select the required language using the key for language selection.
- Then, select the number of required zones.
- Press key [load defaults].
The terminal generates an address list and descriptions for the controller channels.
- If necessary, change the shown dimension for the temperature (°C or °F)

If necessary, channel descriptions and address allocation can be adapted individually.

- Name: channel description with max. 10 characters
- Device: Modbus coupler addresss
- Channel: channel number in the relevant KS-Vario

Press the arrow keys for access to the other controller channels.

 **Please, don't forget to store the basic settings !**

Touch [X] for exit from the set-up dialogue.

Leave the configuration menu via [Menu] or [X].

Select [Survey].

Basic principles of operation

The survey page (only KsvarioBT and KsvarioBT3)

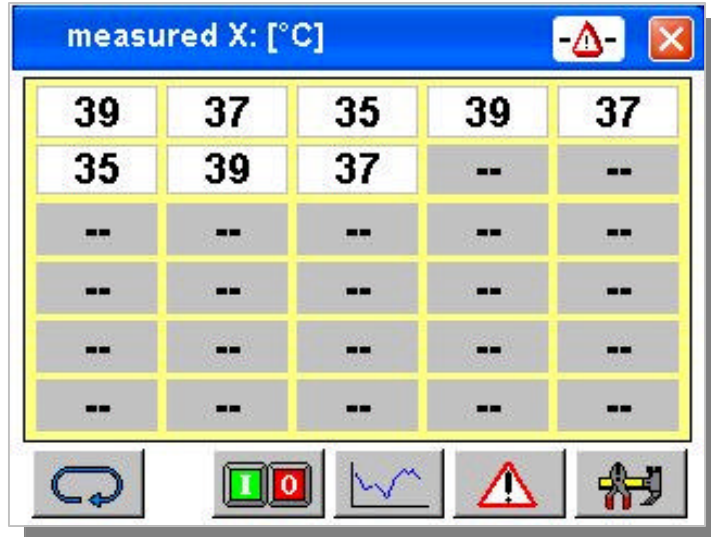

The controller channel process values are displayed on the survey page. Touch [toggle] at the bottom left for display switch-over to other measured values. In case of alarms, status display of the relevant channel is by means of the following colors:

Limit alarms	Low slarm	Out-of-tolerance	High alarm
Limit 3	blue blinking	orange blinking	red blinking
Limit 2	blue	orange	red
Limit 1	light blue	light orange	light red

Sensor break	Display "ERR" black / white blinking
---------------------	--------------------------------------

Direct selection of important dialogues

When touching a displayed measured value, the page with detail information on the relevant channel is opened. Return to the survey by touching icon [spectacles], or via the menu.

For channel group switch-on/off, change to the main operating page via [I/O].

This page provides buttons for heating on, heating off and for standby.

Return from this page to the survey is also by touching icon [spectacles], or via the menu.

The survey page (only KsvarioBT12)

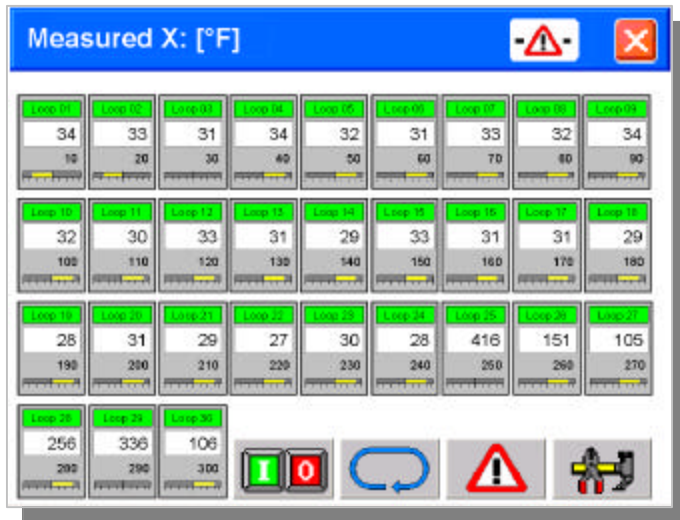

The survey page provides display of process values, setpoints, zone number and output in per cent as a bargraph for the controller channels.
In case of alarms, the status of the relevant channel is displayed in color as follows:

Limitalarms	Low Alarm	Exceeded tolerance	High alarm
Limit 3	<i>blue blinking</i>	<i>orange blinking</i>	<i>red blinking</i>
Limit 2	<i>blue</i>	<i>orange</i>	<i>red</i>
Limit 1	<i>light blue</i>	<i>light orange</i>	<i>light red</i>
Sensor break	<i>"ERR" is displayed blinkingly in black / white.</i>		

With the controller switched off, the process value is displayed with gray background. Fur unused channels (see Configuration), display of values and zone numbers is suppressed.

Direct selection of important dialogues

By touching a displayed measured value, the page containing detailed information on the relevant channel is displayed.

For channel group switch-on/off, change to the main operating page via [I/O].

This page provides buttons for heating on, heating off and for standby.

Return from this page to the survey is also by touching icon [spectacles], or via the menu.

Touch button <Select> for process value display switch-over between temperature, output in percent, control deviation and heating current. Indication which process value is displayed is beside the select button.

Status indication (background color of the channel names)

Green	<i>The relevant channel is active</i>
Blue	<i>Reduced setpoint w2 is active for the relevant channel</i>
Grey	<i>The relevant channel is disabled (coff)</i>

The controller page

On the pages for controller operation per channel, the most important information on a controller is displayed and can be changed.

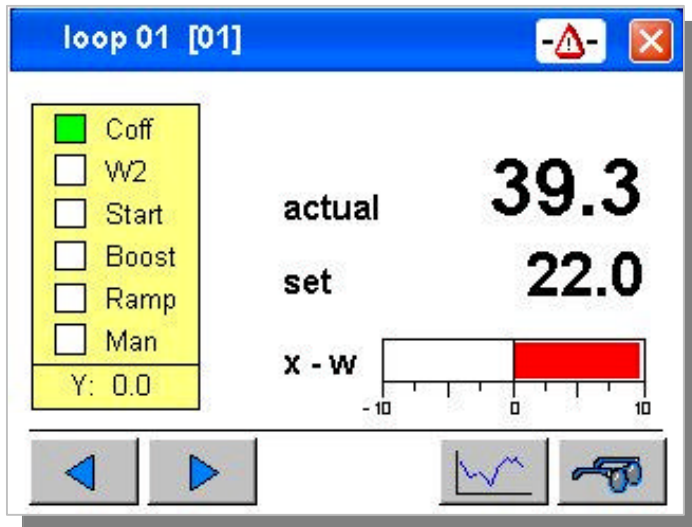

Green status displays:

- Coff The controller is switched off; for switching on, touch the item.
- W2 The controller uses the 2nd setpoint; switch-over is possible by touching.
- Start The start-up circuit is active.
- Boost The boost program is active; de-activation is possible by touching.
- Ramp A setpoint gradient is active.
- Man The controller operates in manual mode; activation is possible by touching.

Touching the setpoint will display a keypad for entry of the setpoint.
 During manual mode, the manual correcting variable is displayed in this position.
 Touch the arrow keys for access to the controller channels.
 The channel is displayed in the header.

i If the adjusted value is different from the effective setpoint, e.g. due to an active setpoint ramp, the color of the displayed setpoint is changed.
 In this case, the adjusted value is displayed below the setpoint for entry.

The page for controller group operation

On this page, the overall system or parts thereof can be switched on and off.

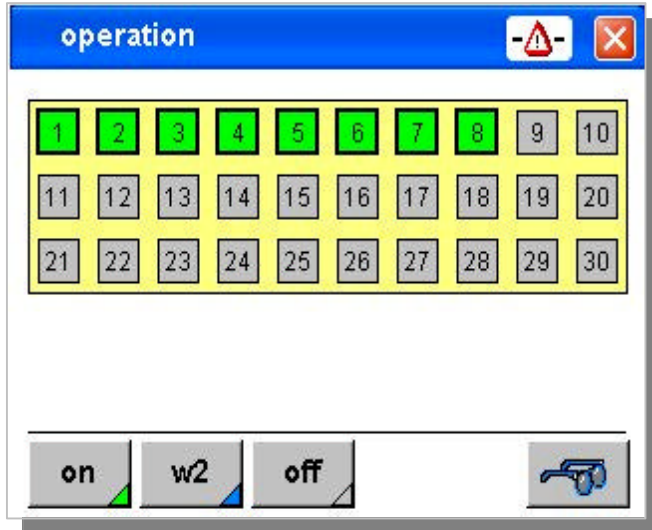

Touching buttons [on], [off] and [w2] always influences all channels displayed with bold border lines.

Normally (no groups configured), all activated zones are selected initially. Channels which should not be active must be de-selected individually.

During group operation, no zone is selected initially. Individual channels or groups can be selected.

Status display

Green	The relevant controller is active.
Blue	Lowering setpoint w2 of the channel is active.
Gray	The controller is switched off (coff).

The trend page

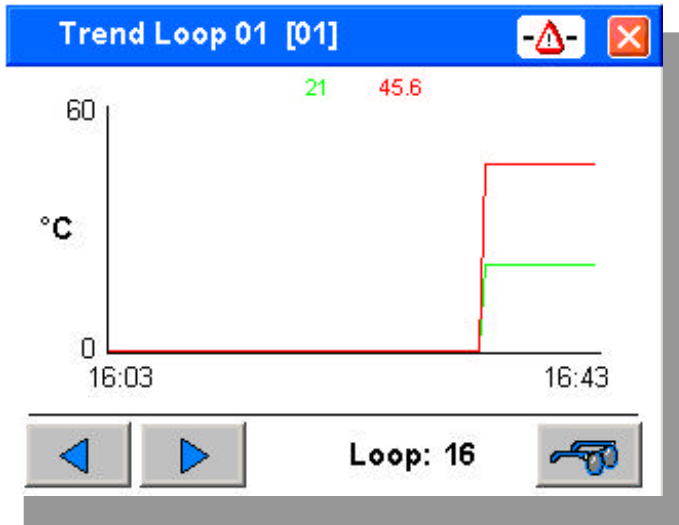

The setpoint and process value curves over the last 40 minutes are displayed on the trend page. Additionally, a horizontal cursor indicates the instantaneously active setpoint. Selection of a different channel is possible by touching the arrow buttons, or by direct input on the bottommost line. Y-axis scaling is done automatically. The **actual** value is displayed on the right !

Limit values

Limits 01..06				
Loop	Lim(1)	Lim(2)	Lim(3)	(HC)
Loop 01 :	20.0	120.0	750.0	2.0
Loop 02 :	20.0	120.0	750.0	2.0
Loop 03 :	20.0	120.0	750.0	2.0
Loop 04 :	20.0	120.0	750.0	2.0
Loop 05 :	20.0	120.0	750.0	2.0
Loop 06 :	20.0	120.0	750.0	2.0

← →

■ low ■ tol
■ high ■ off

🔍

This page is used for alarm parameter setting. Three limit values per channel can be entered. The monitoring mode (min., max. limit value monitoring or tolerance check) is determined by KS vario configuration and parameter setting.

The limit value configuration is indicated only in colors by the operating terminal.

- low low limit value monitoring is active
- high high limit value monitoring is active
- tol checking for min. and max. tolerance related to the setpoint is active
- off channel limit value monitoring is switched off

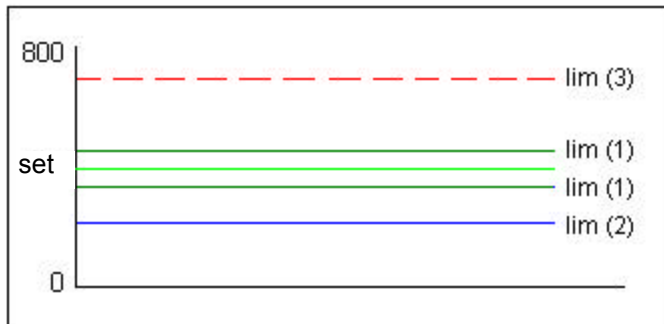

Example: Channels 1..4 of the limit page shown above

i Dependent on KS vario configuration, min./max. limit values related to the setpoint, or absolute limit values can be effective.

Input:

The setpoints of the active alarms can be changed as follows:
 Scroll through the display using the arrow keys, until the relevant channel is displayed. Touch the relevant value to display a keypad for entry.

! **KS vario must always be configured accordingly in advance !**

Alarm screen

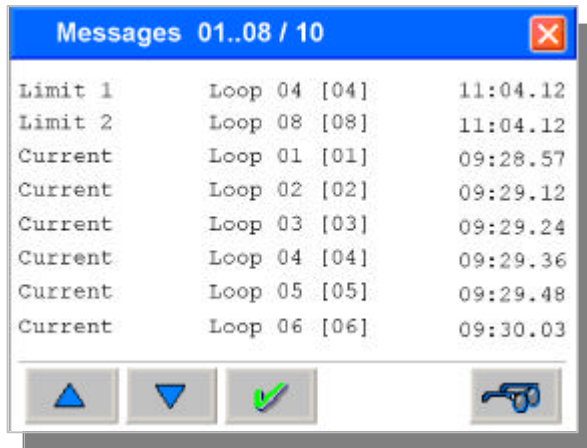

The screenshot shows a window titled "Messages 01..08 / 10" with a close button (X) in the top right corner. The window contains a table with three columns: the first column lists alarm types (Limit 1, Limit 2, Current), the second column lists loop identifiers (Loop 04 [04], Loop 08 [08], Loop 01 [01], Loop 02 [02], Loop 03 [03], Loop 04 [04], Loop 05 [05], Loop 06 [06]), and the third column shows timestamps (11:04.12, 11:04.12, 09:28.57, 09:29.12, 09:29.24, 09:29.36, 09:29.48, 09:30.03). Below the table are four buttons: a blue upward arrow, a blue downward arrow, a green checkmark, and a blue key icon.

Alarm Type	Loop ID	Timestamp
Limit 1	Loop 04 [04]	11:04.12
Limit 2	Loop 08 [08]	11:04.12
Current	Loop 01 [01]	09:28.57
Current	Loop 02 [02]	09:29.12
Current	Loop 03 [03]	09:29.24
Current	Loop 04 [04]	09:29.36
Current	Loop 05 [05]	09:29.48
Current	Loop 06 [06]	09:30.03

All alarm messages of the KSvario are shown in an alarm table. Max. 8 alarm messages are visible on the screen. If there are more alarms active, it's possible to scroll the screen with the UP and DOWN keys.

It's possible to configure the KSvario to generate latched alarms. This latched alarms are active until they will be resetted with the  key. If the alarm reason has not gone before the reset, the alarm message is still shown in the alarm table

Unlatched alarms are in the alarmtable while the alarm reason is given. Has the alarm reason gone, the alarm message will be automatically deleted from the alarm screen!

Parameter setting and special dialogues

The parameter page

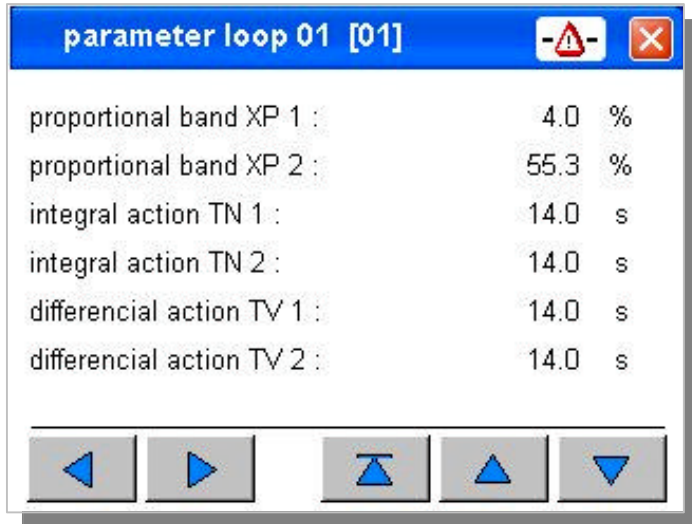

The parameter page provides a survey of important channel parameter settings.

Use the arrow keys (up/down) to scroll through the list.

Touch arrow keys (left/right) for switch-over to the next controller channel.

When touching a parameter value, a keypad for input of the relevant value is displayed.

Self-tuning

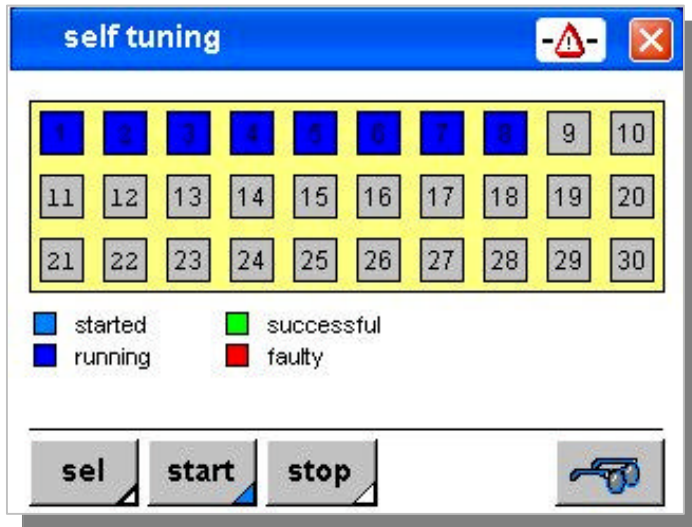

The terminal supports individual and groupwise controller self-tuning. Start channel selection using button [sel]. For single self-tuning, select the relevant channels from the upper list by touching with your finger. Self-tuning groups defined in KS vario can be selected via [OptGrp 1 .. OptGrp 4]. After selecting the required zone, the choice can be activated in KS vario by touching button [Start]. During self-tuning, further self-tuning attempts can be started with [Sel] and [Start]. Touching button [stop] cancels all running self-tuning attempts.

i For self-tuning, the relevant controllers must be switched on. When all selected controllers are switched off, button [hand] is displayed. Touching this button will switch on all selected controllers in manual mode with correcting variable=0.

Unless the select function is active, status display of the relevant channel is possible by touching a channel field.

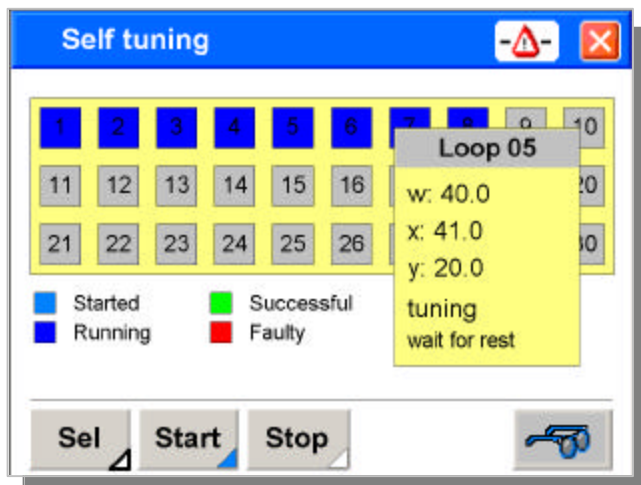

Group operation

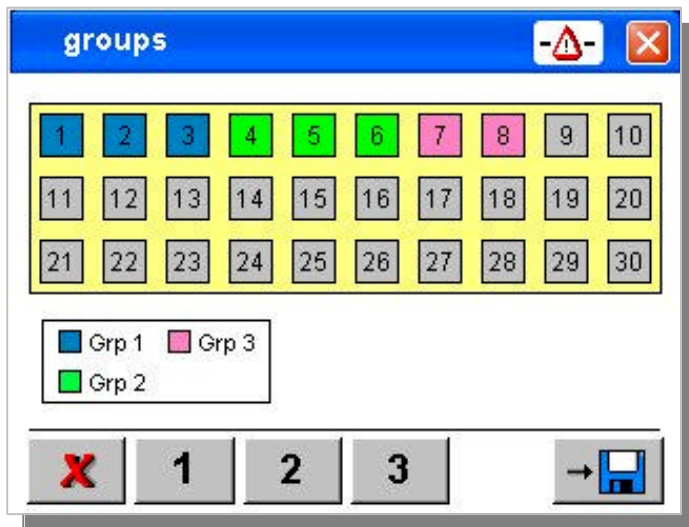

Max. three groups can be formed for partial switch-on/off of a system consisting of several parts. To compose a group, select the controllers to be included in a group on the page for group configuration and actuate button [1], [2] or [3] dependent on group. Button [X] can be used to remove selected controllers from a group.

i If groups are defined, the relevant buttons for group selection are displayed on the operating page.

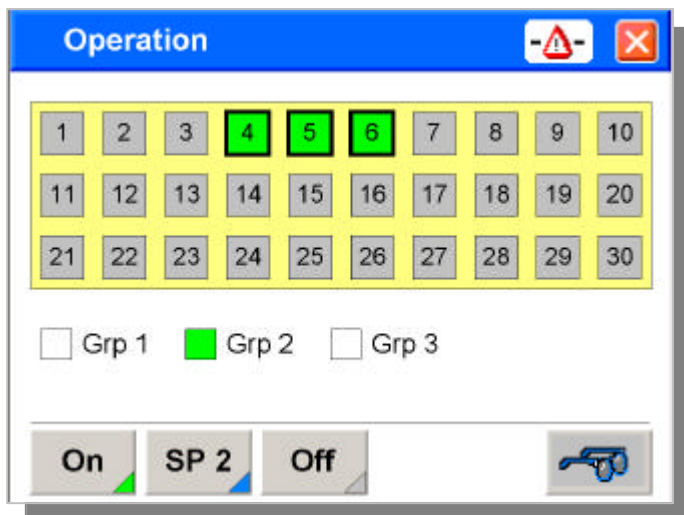

i Please, store the group setting, if it should be used continuously !

Copying settings

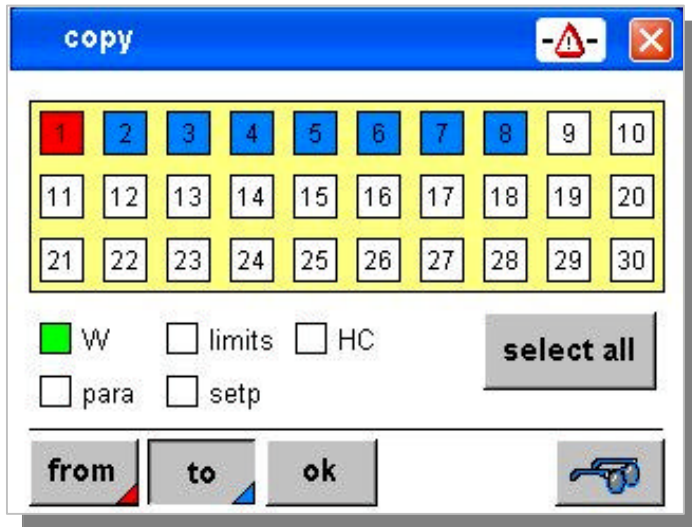

For utmost management efficiency of the multitude of parameter settings, copying of the settings to other controller channels is possible. For this purpose, the copying dialogue page is used. Setpoints, parameters and limit values can be copied.

Procedure:

- Adjust all relevant values for a controller channel.
- Open the operating page for copying.
- Select the settings which should be copied (W, limits, ...)
- Touch button [from] and select the source.
- Now, touch button [to] and select the controllers, which shall be provided with identical values.
- The entry can be accelerated by touching button [select all].
- Touch button [ok] to copy the values.

W	copies the effective setpoint
limits	copies tol(1), tol(2) and max. values
HC	copies the heating current limit value
para	copies parameter TN, TV, XP, T
setp	copies SP2, boost, start-up, gradient

Recipes

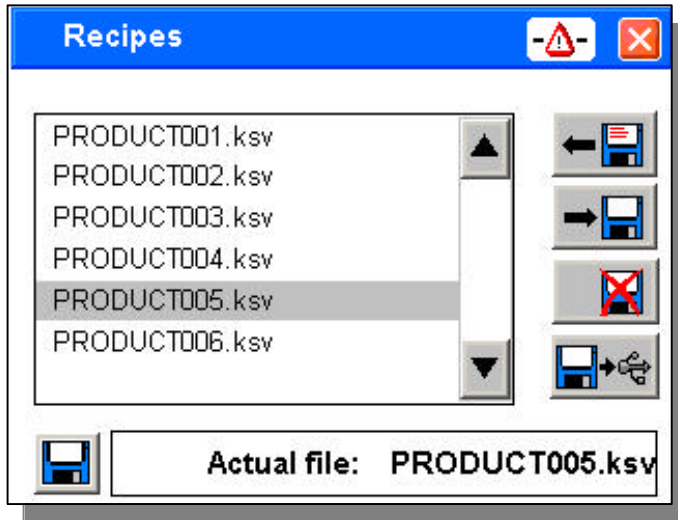

Settings can be stored in the terminal as recipes.

Storing:

Touch line "File: __ " and enter a file name.

Existing files which should be overwritten can be selected simply from the list. Touch [write] to save the data.

Read:

Select a data set from the list.

Touch [read] for data reading.

Deleting data sets:

Select a data set from the list.

Touch [delete] to delete the data.



Recipes are saved as files on the internal Flash memory or on an external USB stick.
Recipe files always have extension (.ksv).

Passwords

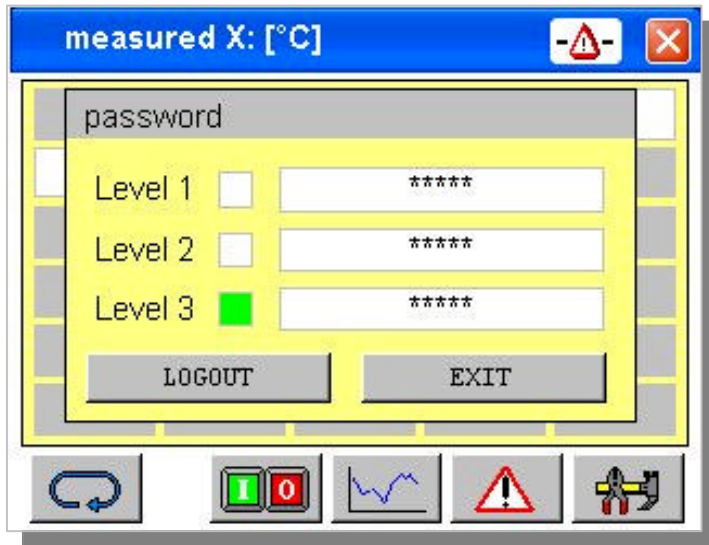

Data entries via the KS vario operating terminal can be interlocked by means of three access levels. Opening a password dialogue is possible via the parameter menu on the main operating page. This dialogue offers three user levels. If a terminal is new, no passwords are stored and access to all data is possible (level 3).

To activate the user management, passwords for disabling user levels must be stored.

USER LEVEL

Level 1:	setpoints, heating on/off, ...
Level 2:	parameters, limit values, ...
Level 3:	operating terminal configuration

Activating a user level and changing passwords:

The password of the instantaneously enabled level and of the lower levels can be changed. Definition of a new password is by entering the password for the relevant user level twice. “#” should be used as a separator between the two entries.

Example

Input of "1234#1234" on line "Level 3" defines "1234" as a new password for user level 3. To delete a password, simply enter "#".

Logging in and out:

Open the password dialogue via the parameter menu on the survey page. If log-in was already done, or in case no passwords are stored, the instantaneous user level is displayed in the status fields.

For logging out, simply touch [LOGOUT]
 To log in, enter the valid password in the field for the required user level.
 Touch [EXIT] for exit from the dialogue.

Technical data

COMPUTER

KSvarioBT 3 / KSvarioBT

CPU: Intel XscalePXA270 (312/416MHz)
Passive cooling
64 MByte RAM onboard
32/64 MByte Flash-memory onboard

KSvarioBT 12

CPU: GX3 LX800 (500MHz)
Passive cooling
256 MByte RAM onboard

DISPLAY

KSvarioBT

5,7-inch FSTN color LC display
QVGA 320 x 240 pixel resolution
256 colors, approx. 180 cd/qm
resistive touch

KSvarioBT 12

12,1" color TFT Display,
Resolution: SVGA 800 x 600 pixel
256k colours 300 cd/qm
resistive touch

INTERFACES

Connection for KSVARIO Modbus coupler (COM3 with KsvarioBT, COM4 with KsvarioBT12)

Type: RS485, 9-pole Sub-D connector
Max. cable length: 1000m

Connection for KS vario BlueControl interface (COM1)

Type: V.24 / RS232, 9-pole Sub-D connector
Max. cable length: 3m

Network

Ethernet interface (10 /100Base-T)

USB interface

2 x USB (Type A) KSvarioBT 12
2 x USB (1xType A, 1xTyp B) KSvarioBT
1 x USB (1 Type A mini with adapter,
KSvarioBT 3 only)

Memory extension

1 x SD-Card (KSvarioBT 3 only)
1 x Compact-Flash-Card Type I (KSvarioBT and KSvarioBT 12 only)

POWER SUPPLY

Operating voltage: 24 V DC (18..32 V DC)
KSvarioBT 3 ≤ 10W (8 .. 28 V DC)
KSvarioBT ≤ 20W
KSvarioBT 12 ≤ 60W
Protection class III (protective low voltage)

ENVIRONMENTAL CONDITIONS

Permissible temperatures
Operating temperature 0...50°C
Storage/transport -20...60 °C

CLIMATIC CATEGORY:

Relative humidity: 10 ..95 % at 40°C, no condensation

INFLUENCING FACTORS

Supply voltage

Without effect. No loss of configuration data in case of power failure (flash PROM storage).

Vibration test

Sinusoidal vibrations according to
IEC 60068-2-6; EN 60068-2-6;
Load: 2g, 1 h for each space direction

Shock test

acc. to IEC 60068-2-27; EN 60068-2-27
Load: 10g during 11 ms, half-sinusoidal wave,
three shocks in each space direction and orientation

ELECTROMAGNETIC COMPATIBILITY

Electromagnetic immunity

To EN 50 082-2
All interface cables must be screened.

Electromagnetic radiation

To EN 50 081-2
Radiation from housing: Class A in accordance with EN 55 011

GENERAL

Housing

KSvarioBT

Dimensions (WxHxD): 195x148x45 [mm]
Panel cut-out: 188x141 [mm]

KsvarioBT12

Dimensions (WxHxD): 311x237x50 [mm]
Panel cut-out: 302x228 [mm]

Weight

KSvarioBT 3 / KSvarioBT / KSvarioBT 12:
ca. 0,3 kg / 0,8 kg / 2,2kg

Protection type

Front: IP 65
Rear: IP 20

Safety

Meets EN 61010-1 (VDE 0411-1):
Overvoltage category II
Degree of contamination 2
Operating voltage range 50 V
Protection class III

CE marking

Meets the guidelines for electromagnetic compatibility and the low-voltage guideline.

Accessories delivered with the unit

Connection terminal for the operating voltage

Mounting accessories